



---

# SPEEDMASTER®

SM PLUS SERIES SUB-MICRO INVERTERS

---





Installation and Operation Manual





## TABLE OF CONTENTS

1.0	GENERAL .....	1
2.0	SM-Plus™ DIMENSIONS .....	2
4.0	SM-Plus™ SPECIFICATIONS .....	4
5.0	SM-Plus™ RATINGS .....	5
6.0	INSTALLATION .....	7
7.0	INPUT AC POWER REQUIREMENTS .....	8
8.0	POWER WIRING .....	10
9.0	SM-Plus™ POWER WIRING DIAGRAM .....	11
10.0	CONTROL WIRING .....	12
11.0	SM-Plus™ CONTROL WIRING DIAGRAMS .....	15
12.0	INITIAL POWER UP AND MOTOR ROTATION .....	20
13.0	PROGRAMMING THE SM-Plus™ DRIVE .....	22
14.0	PARAMETER MENU .....	26
15.0	DESCRIPTION OF PARAMETERS .....	29
16.0	TROUBLESHOOTING .....	45
17.0	SM-Plus™ DISPLAY MESSAGES .....	47
	APPENDIX B - PI SETPOINT CONTROL OPTION .....	49

## IMPORTANT NOTICE

The following ,  and  information is supplied to you for your protection and to provide you with many years of trouble free and safe operation of your LEESON Electric product.

-  **DANGER**
  - Hazard of electrical shock! Capacitors retain charge after power is removed. Disconnect incoming power and wait until the voltage between terminals B+ and B- is 0 VDC before servicing the drive.
  - Hazard of electrical shock! Wait three minutes after disconnecting incoming power before servicing drive. Capacitors retain charge after power is removed.
  - Automatic starting of equipment may cause damage to equipment and / or injury to personnel! Automatic start should only be used on equipment that is inaccessible to personnel.
-  **WARNING**
  - DRIVES MUST NOT BE INSTALLED WHERE SUBJECTED TO ADVERSE ENVIRONMENTAL CONDITIONS SUCH AS: COMBUSTIBLE, OILY, OR HAZARDOUS VAPORS OR DUST; EXCESSIVE MOISTURE OR DIRT; VIBRATION; EXCESSIVE AMBIENT TEMPERATURES. CONSULT LEESON ELECTRIC FOR MORE INFORMATION ON THE SUITABILITY OF A DRIVE TO A PARTICULAR ENVIRONMENT.
  - Severe damage to the drive can result if it is operated after a long period of storage or inactivity without reforming the DC bus capacitors!
  - Do not connect incoming AC power to output terminals T1, T2, or T3. Severe damage to the drive will result.
  - When operating in JOG mode, the STOP terminal (TB-1) and the STOP key (on the optional remote keypad) **WILL NOT** stop the drive. To stop the drive, remove the JOG command.
  - When operating in JOG mode, the STOP terminal (TB-1), the AUXILIARY STOP function (see setting 08), and the STOP key on the optional remote keypad WILL NOT stop the drive. To stop the drive, remove the JOG command.
  - JOG REVERSE will operate the drive in reverse rotation even if ROTATION DIRECTION (Parameter 17) is set to FORWARD ONLY.
  - DO NOT connect incoming AC power to output terminals T1, T2, and T3! Severe damage to the drive will result. Do not continuously cycle input power to the drive more than once every two minutes. Damage to the drive will result.
  - Do not remove the EPM while power is applied to the drive. Damage to the EPM and/or drive may result.
  - Controlling the drive from the serial link without the watchdog timer could cause damage to equipment and/or injury to personnel!
-  **CAUTION**
  - Consult qualified personnel with questions. All electrical repairs must be performed by trained and qualified personnel only.

### Resale of Goods:

In the event of the resale of any of the goods, in whatever form, Resellers/Buyers will include the following language in a conspicuous place and in a conspicuous manner in a written agreement covering such sale:

The manufacturer makes no warranty or representations, express or implied, by operation of law or otherwise, as the merchantability or fitness for a particular purpose of the goods sold hereunder. Buyer acknowledges that it alone has determined that the goods purchased hereunder will suitably meet the requirements of their intended use. In no event will the manufacturer be liable for consequential, incidental or other damages. Even if the repair or replacement remedy shall be deemed to have failed of its essential purpose under Section 2-719 of the Uniform Commercial Code, the manufacturer shall have no liability to Buyer for consequential damages.

Resellers/Buyers agree to also include this entire document including the warnings and cautions above in a conspicuous place and in a conspicuous manner in writing to instruct users on the safe usage of the product.

**LEESON Electric**  
**SPEEDMASTER® SM-PLUS™**  
SUB-MICRO DRIVE

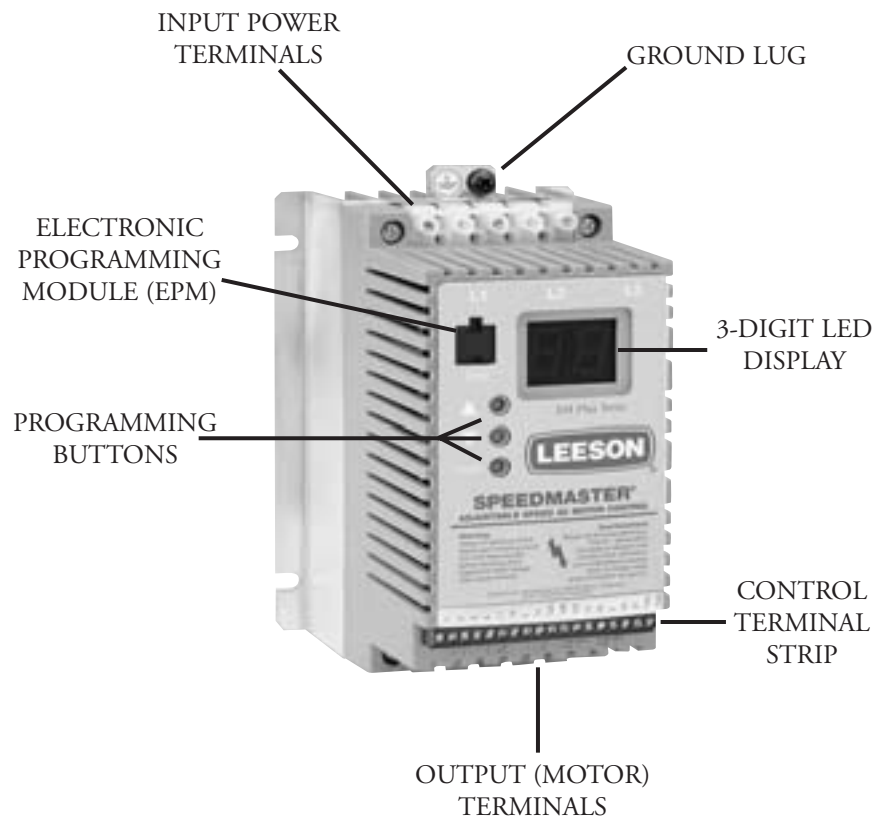

## 1.0 GENERAL

### 1.1 PRODUCTS COVERED IN THIS MANUAL

This manual covers the LEESON Electric SM-Plus™ Variable Frequency Drive.

### 1.2 PRODUCT CHANGES

LEESON Electric reserves the right to discontinue or make modifications to the design of its products without prior notice, and holds no obligation to make modifications to products sold previously. LEESON Electric also holds no liability for losses of any kind which may result from this action.

### 1.3 WARRANTY

LEESON Electric warrants the SM-Plus™ AC motor control to be free of defects in material and workmanship for a period of twelve months from the date of sale to the user, or eighteen months from the date of shipment, whichever occurs first. If a SM-Plus™ motor control, under normal use, becomes defective within the stated warranty time period, contact LEESON's Service Department for instructions on obtaining a warranty replacement unit. LEESON Electric reserves the right to make the final determination as to the validity of a warranty claim, and sole obligation is to repair or replace only components which have been rendered defective due to faulty material or workmanship. No warranty claim will be accepted for components which have been damaged due to mishandling, improper installation, unauthorized repair and/or alteration of the product, operation in excess of design specifications or other misuse, or improper maintenance. LEESON Electric makes no warranty that its products are compatible with any other equipment, or to any specific application, to which they may be applied and shall not be held liable for any other consequential damage or injury arising from the use of its products.

**This warranty is in lieu of all other warranties, expressed or implied. No other person, firm or corporation is authorized to assume, for LEESON Electric, any other liability in connection with the demonstration or sale of its products.**

**NOTE 1:** LEESON will match mode of transportation if drive is repaired under warranty. Customer will be invoiced for shipping if no problem is found, if the repair is non-warranty, or if the return mode is different.

**NOTE 2:** There is a minimum inspection fee of \$100.00 if no problem is found. There is an additional charge of 25% for Rush Service.

### 1.4 RECEIVING

Inspect all cartons for damage which may have occurred during shipping. Carefully unpack equipment and inspect thoroughly for damage or shortage. Report any damage to carrier and/or shortages to supplier. All major components and connections should be examined for damage and tightness, with special attention given to PC boards, plugs, knobs and switches.

### 1.5 CUSTOMER MODIFICATION

LEESON Electric, its sales representatives and distributors, welcome the opportunity to assist our customers in applying our products. Many customizing options are available to aid in this function. LEESON Electric cannot assume responsibility for any modifications not authorized by its engineering department.

## 2.0 SM-Plus™ DIMENSIONS

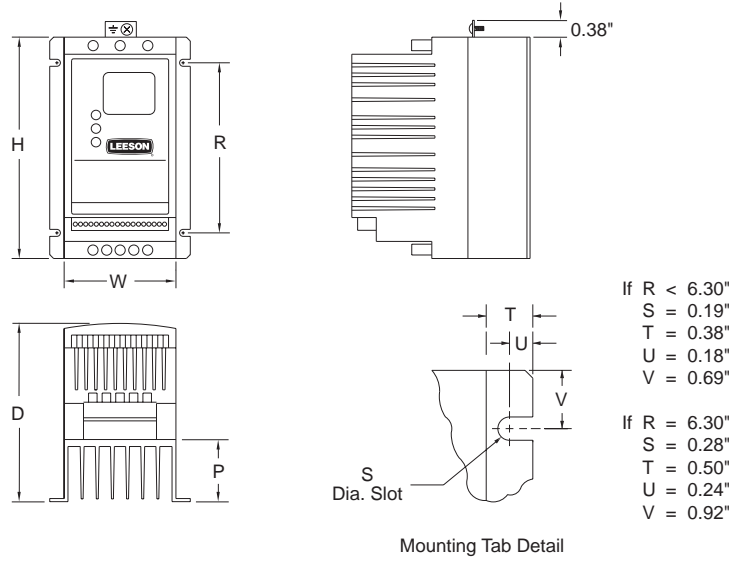

HP	kW	INPUT		H	W	D	P	R
		VOLTAGE	MODEL					
0.25	0.20	208 / 240	174452	5.75 (146)	2.88 (73)	3.94 (100)	0.80 (20)	4.37 (111)
0.5	0.37	208 / 240	174453	5.75 (146)	2.88 (73)	3.94 (100)	0.80 (20)	4.37 (111)
		400 / 480	174459	5.75 (146)	2.88 (73)	3.94 (100)	0.80 (20)	4.37 (111)
1	0.75	120/280/240	174492	5.75 (146)	3.76 (96)	5.24 (133)	1.90 (48)	4.37 (111)
		208 / 240	174454	5.75 (146)	2.88 (73)	4.74 (120)	1.60 (41)	4.37 (111)
		208 / 240	174455	5.75 (146)	2.88 (73)	4.74 (120)	1.60 (41)	4.37 (111)
		400 / 480	174460	5.75 (146)	2.88 (73)	4.74 (120)	1.60 (41)	4.37 (111)
1.5	1.1	120/280/240	174445	5.75 (146)	3.76 (96)	5.24 (133)	1.90 (48)	4.37 (111)
		208 / 240	174493	5.75 (146)	3.76 (96)	5.24 (133)	1.90 (48)	4.37 (111)
		208 / 240	174456	5.75 (146)	2.88 (73)	5.74 (146)	2.60 (66)	4.37 (111)
		400 / 480	174461	5.75 (146)	2.88 (73)	5.74 (146)	2.60 (66)	4.37 (111)

		INPUT						
HP	kW	VOLTAGE	MODEL	H	W	D	P	R
2	1.5	208 / 240	174494	5.75 (146)	3.76 (96)	6.74 (171)	3.40 (86)	4.37 (111)
		208 / 240	174457	5.75 (146)	2.88 (73)	5.74 (146)	2.60 (66)	3.06 (78)
		400 / 480	174462	5.75 (146)	2.88 (73)	5.74 (146)	2.60 (66)	4.37 (111)
		480 / 590	174491	5.75 (146)	2.88 (73)	5.74 (146)	2.60 (66)	4.37 (111)
3	2.2	208 / 240	174495	5.75 (146)	3.76 (96)	6.74 (171)	3.40 (86)	3.25 (83)
		208 / 240	174458	5.75 (146)	2.88 (73)	5.74 (146)	2.60 (66)	3.06 (78)
		400 / 480	174463	5.75 (146)	2.88 (73)	5.74 (146)	2.60 (66)	3.06 (78)
		480 / 590	174497	5.75 (146)	3.76 (96)	6.74 (171)	3.40 (86)	4.37 (111)
5	3.7	208 / 240	174444	7.75 (197)	5.02 (128)	7.18 (182)	3.40 (86)	4.81 (122)
		208 / 240	174446	5.75 (146)	3.76 (96)	6.74 (171)	3.40 (86)	3.25 (83)
		400 / 480	174447	5.75 (146)	3.76 (96)	6.74 (171)	3.40 (86)	3.25 (83)
		480 / 590	174448	5.75 (146)	3.76 (96)	6.74 (171)	3.40 (86)	3.25 (83)
7.5	5.5	208 / 240	174438	7.75 (197)	5.02 (128)	7.18 (182)	3.40 (86)	4.81 (122)
		400 / 480	174440	7.75 (197)	5.02 (128)	7.18 (182)	3.40 (86)	4.81 (122)
		480 / 590	174442	7.75 (197)	5.02 (128)	7.18 (182)	3.40 (86)	4.81 (122)
10	7.5	208 / 240	174439	7.75 (197)	5.02 (128)	7.18 (182)	3.40 (86)	4.81 (122)
		400 / 480	174441	7.75 (197)	5.02 (128)	7.18 (182)	3.40 (86)	4.81 (122)
		480 / 590	174443	7.75 (197)	5.02 (128)	7.18 (182)	3.40 (86)	4.81 (122)
15	11	208 / 240	174429	9.75 (248)	6.68 (170)	8.00 (203)	3.60 (91)	6.30 (160)
		400 / 480	174431	9.75 (248)	6.68 (170)	8.00 (203)	3.60 (91)	6.30 (160)
		480 / 590	174434	9.75 (248)	6.68 (170)	8.00 (203)	3.60 (91)	6.30 (160)
20	15	208 / 240	174430	9.75 (248)	6.68 (170)	8.00 (203)	3.60 (91)	6.30 (160)
		400 / 480	174432	9.75 (248)	6.68 (170)	8.00 (203)	3.60 (91)	6.30 (160)
		480 / 590	174435	9.75 (248)	6.68 (170)	8.00 (203)	3.60 (91)	6.30 (160)
25	18.5	400 / 480	174433	9.75 (248)	6.68 (170)	8.00 (203)	3.60 (91)	6.30 (160)
		480 / 590	174436	9.75 (248)	6.68 (170)	8.00 (203)	3.60 (91)	6.30 (160)



#### 4.0 SM-Plus™ SPECIFICATIONS

Storage Temperature	-20° to 70° C
Ambient Operating Temperature	0° to 50° C (up to 6 kHz carrier, derate above 6 kHz)
Ambient Humidity	<95% (non-condensing)
Maximum Altitude	3300 ft (1000m) above sea level (without derating)
Input Line Voltages	120/208/240 VAC, 208/240 Vac, 400/480 Vac, 480/590 Vac
Input Voltage Tolerance	+10%, -15%
Input Frequency Tolerance	48 to 62 Hz
Output Wave Form	Sine Coded PWM
Output Frequency	0 - 240 Hz (consult Factory for higher output frequencies)
Carrier Frequency	4 kHz to 10 kHz
Service Factor	1.00 (up to 6 kHz carrier, derate above 6 kHz)
Efficiency	Up to 98%
Power Factor (displacement)	0.96 or better
Overload Current Capacity	150% for 60 seconds, 180% for 30 seconds
Speed Reference Follower	0 - 10 VDC, 4 - 20 mA
Control Voltage	15 VDC
Power Supply for Auxiliary Relays	50 mA at 12 VDC
Analog Outputs	0 - 10 VDC or 2 - 10 VDC: Proportional to frequency or load
Digital Outputs	Open-collector outputs: 50 mA at 30 VDC

## 5.0 SM-Plus™ RATINGS

MODEL NUMBER	FOR MOTORS RATED		INPUT (50-60 Hz)			OUTPUT	HEAT LOSS (WATTS) (NOTE 2)
			INPUT PHASE	CURRENT (AMPS) (NOTE 1)	POWER (kVA)	CURRENT (AMPS)	
	HP	kW				120/208/240 VAC	
174492	1	0.75	1	16.6/9.6/8.3	2.0	4.2/4.8/4.2	48
174445	1.5	1.1	1	24/13.9/12.0	2.9	6.0/6.9/6.0	73
			208/240 Vac			0 - 200/230 Vac	
174452	0.25	0.20	1	3.6/3.2	0.76	1.6/1.4	19
174452	0.25	0.20	3	1.9/1.7	0.71	1.6/1.4	19
174453	0.5	0.37	1	5.4/4.7	1.2	2.5/2.2	26
174453	0.5	0.37	3	3.1/2.7	1.1	2.5/2.2	26
174454	1	0.75	1	10.6/9.2	2.2	4.8/4.2	49
174454	1	.075	3	5.8/5.1	2.1	4.8/4.2	49
174493	1.5	1.1	1	13.9/12.0	2.9	6.9/6.0	82
174493	1.5	1.1	3	8.0/6.9	2.9	6.9/6.0	82
174494	2	1.5	1	14.8/12.9	3.1	7.8/6.8	86
174494	2	1.5	3	9.1/7.9	3.2	7.8/6.8	86
174495	3	2.2	1	19.7/17.1	4.1	11.0/9.6	130
174495	3	2.2	3	12.4/10.8	4.4	11.0/9.6	130
174444	5	3.7	1	29/26	6.1	17.5/15.2	212
174444	5	3.7	3	19.6/17.1	7.1	17.5/15.2	212
			208/240 Vac			0 - 200/230 Vac	
174455	1	0.75	3	5.8/5.1	2.1	4.8/4.2	41
174456	1.5	1.1	3	8.0/6.9	2.9	6.9/6.0	69
174457	2	1.5	3	9.1/7.9	3.3	7.8/6.8	78
174458	3	2.2	3	12.4/10.8	4.5	11.0/9.6	117
174446	5	3.7	3	19.6/17.1	7.1	17.5/15.2	187
174438	7.5	5.5	3	28/25	10.3	25/22	286
174439	10	7.5	3	34/32	13.1	30/28	379
174429	15	11	3	54/48	20.0	48/42	476
174430	20	15	3	65/61	25.4	58/54	648

**NOTE 1:** The higher current ratings are for 208 Vac input and the lower current ratings are for 240 Vac input.

**NOTE 2:** Values are worst-case (not typical) for 6 kHz carrier frequency at full speed and full load.

MODEL NUMBER	FOR MOTORS RATED		INPUT (50-60 Hz)			OUTPUT	HEAT LOSS (WATTS) (NOTE 2)
	HP	kW	INPUT PHASE	CURRENT (AMPS)	POWER (kVA)	CURRENT (AMPS)	
			400/480 Vac (NOTE 3)			0 - 400/460 Vac	
174459	0.5	0.37	3	1.6/1.4	1.1	1.3/1.1	26
174460	1	0.75	3	2.9/2.5	2.1	2.4/2.1	40
174461	1.5	1.1	3	4.0/3.6	3.0	3.4/3.0	56
174462	2	1.5	3	4.6/4.0	3.3	3.9/3.4	67
174463	3	2.2	3	6.2/5.4	4.5	5.5/4.8	100
174447	5	3.7	3	9.8/8.6	7.1	8.7/7.6	168
174440	7.5	5.5	3	14.2/12.4	10.3	12.6/11.0	254
174441	10	7.5	3	18.1/15.8	13.1	16.1/14.0	310
174431	15	11	3	27/24	20.0	24/21	390
174432	20	15	3	35/31	25.8	31/27	530
174433	25	18.5	3	44/38	31.6	39/34	648
			480/590 Vac (NOTE 4)			0 - 460/575 Vac	
174464	1	0.75	3	2.2/2.0	1.9/2.0	1.9/1.7	40
174491	2	1.5	3	4.0/3.5	3.3/3.6	3.4/3.0	67
174497	3	2.2	3	4.7/4.7	3.9/4.8	4.2/4.2	100
174448	5	3.7	3	7.4/7.4	6.1/7.5	6.6/6.6	168
174442	7.5	5.5	3	11.2/11.2	9.3/11.4	9.9/9.9	254
174443	10	7.5	3	13.7/13.7	11.4/14.0	12.2/12.2	310
174434	15	11	3	22/22	18.3/22.5	19.0/19.0	390
174435	20	15	3	27/27	22.4/27.6	24/24	530
174436	25	18.5	3	31/31	25.8/31.7	27/27	648
<p><b>NOTE 2:</b> Values are worst-case (not typical) for 6 kHz carrier frequency at full speed and full load.</p> <p><b>NOTE 3:</b> The higher current ratings are for 400 Vac input and the lower current ratings are for 480 Vac input.</p> <p><b>NOTE 4:</b> The higher current ratings for for 480 Vac input and the lower current ratings are for 590 Vac input.</p>							

## 6.0 INSTALLATION

**NOTE:** SM-Plus™ drives are intended for inclusion within other equipment, by professional electrical installers. They are not intended for stand-alone operation.

**⚠WARNING** DRIVES MUST NOT BE INSTALLED WHERE SUBJECTED TO ADVERSE ENVIRONMENTAL CONDITIONS SUCH AS: COMBUSTIBLE, OILY, OR HAZARDOUS VAPORS OR DUST; EXCESSIVE MOISTURE OR DIRT; VIBRATION; EXCESSIVE AMBIENT TEMPERATURES. CONSULT LEESON ELECTRIC FOR MORE INFORMATION ON THE SUITABILITY OF A DRIVE TO A PARTICULAR ENVIRONMENT.

SM-Plus™ models are suitable for UL pollution degree 2 environment only, and MUST be installed in an electrical enclosure which will provide complete mechanical protection and will maintain the internal temperature within the drive's ambient operating temperature rating. All drives models MUST be mounted in a vertical position for proper heatsink cooling.

Maintain a minimum spacing around the drive of at least 1 inch (25mm) on each side and 2 inches (50mm) on the top and bottom for units rated up to 5 HP (3.7 kW). For units rated 7.5 - 25 HP (5.5-18.5 kW), maintain at least 2 inches (50mm) on each side and 4 inches (100mm) on the top and bottom. Allow more spacing if the drive is mounted next to other heat-producing equipment. Do not mount drives above other drives or heat producing equipment. Fans or blowers should be used to insure proper cooling in tight quarters.

In order to properly size an enclosure, the heat generated by the drive(s) must be known. Refer to the HEAT LOSS columns in Section 5.0 - SM-Plus™ RATINGS. An enclosure manufacturer can then determine the required enclosure size based on the total heat generated inside the enclosure (from the drive(s) and other heat sources), the maximum allowable temperature inside the enclosure, the maximum ambient temperature outside the enclosure, and the enclosure properties.

The SM-Plus™ is UL approved for solid state motor overload protection. Therefore, a separate thermal overload relay is not required for single motor applications.

### 6.1 INSTALLATION AFTER A LONG PERIOD OF STORAGE

**⚠WARNING** Severe damage to the drive can result if it is operated after a long period of storage or inactivity without reforming the DC bus capacitors!

If input power has not been applied to the drive for a period of time exceeding three years (due to storage etc), the electrolytic DC bus capacitors within the drive can change internally, resulting in excessive leakage current. This can result in premature failure of the capacitors if the drive is operated after such a long period of inactivity or storage.

**In order to reform the capacitors and prepare the drive for operation after a long period of inactivity, apply input power to the drive for 8 hours prior to actually operating the motor.**

## 6.2 EXPLOSION PROOF APPLICATIONS

Explosion proof motors that are not rated for inverter use lose their certification when used for variable speed. Due to the many areas of liability that may be encountered when dealing with these applications, the following statement of policy applies:

**“LEESON Electric inverter products are sold with no warranty of fitness for a particular purpose or warranty of suitability for use with explosion proof motors. LEESON Electric accepts no responsibility for any direct, incidental or consequential loss, cost, or damage that may arise through the use of its AC inverter products in these applications. The purchaser expressly agrees to assume all risk of any loss, cost, or damage that may arise from such application.”**

## 7.0 INPUT AC POWER REQUIREMENTS

**⚠ DANGER** Hazard of electrical shock! Capacitors retain charge after power is removed. Disconnect incoming power and wait until the voltage between terminals B+ and B- is 0 VDC before servicing the drive.

The input voltage must match the nameplate voltage rating of the drive. Voltage fluctuation must not vary by greater than 10% overvoltage or 15% undervoltage.

**NOTE:** Drives with dual input voltage ratings must be programmed for the proper supply voltage (refer to Parameter 01 - LINE VOLTAGE SELECTION in Section 15.0 - DESCRIPTION OF PARAMETERS).

The drive is suitable for use on a circuit capable of delivering not more than 5,000 RMS symmetrical amperes at 5 HP (3.7 kW), and below, and 18,000 RMS symmetrical amperes at 7.5 - 25 HP (5.5-18.5 kW) at the drive's rated voltage.

If the kVA rating of the AC supply transformer is greater than 10 times the input kVA rating of the drive(s), an isolation transformer or 2-3% input line reactor must be added to the line side of the drive(s).

Three phase voltage imbalance must be less than 2.0% phase to phase. Excessive phase to phase imbalance can cause severe damage to the drive's power components.

Motor voltage should match line voltage in normal applications. The drive's maximum output voltage will equal the input voltage. Use extreme caution when using a motor with a voltage rating which is different from the input line voltage.

## 7.1 INPUT VOLTAGE RATINGS

Drives are rated for 120/208/240 Vac, single phase, 50-60 Hz input. The drive will function with input voltage of 120 Vac (+10%, -15%), at 48 to 60 Hz, or with input voltage of 208 to 240 Vac (+10%, -15%), at 48 to 62 Hz.

Drives that are rated for 208/240 Vac, three phase, 50-60 Hz input will function with input voltages of 208 to 240 Vac (+10%, -15%), at 48 to 62 Hz.

Drives that are rated for 208/240 Vac, single or three phase, 50-60 Hz input will function with input voltage of 208 to 240 Vac (+10%, -15%), at 48 to 62 Hz.

Drives that are rated for 400/480 Vac, three phase, 50-60 Hz input will function with input voltages of 400 to 480 Vac (+10%, -15%), at 48 to 62 Hz.

Drives that are rated for 480/590 Vac, three phase, 50-60 Hz input will function with input voltages of 480 to 590 Vac (+10%, -15%), at 48 to 62 Hz.

**NOTE:** Parameter 01 - LINE VOLTAGE SELECTION must be programmed according to the applied input voltage. See Section 15.0 - DESCRIPTION OF PARAMETERS.

## 7.2 INPUT FUSING AND DISCONNECT REQUIREMENTS

A circuit breaker or a disconnect switch with fuses must be provided in accordance with the National Electric Code (NEC) and all local codes.

The SM-Plus™ drive is capable of withstanding up to 150% current overload for 60 seconds. Select a fuse or magnetic trip circuit breaker rated at 1.5 times the input current rating of the drive (the minimum size should be 10 amps, regardless of input current rating). Refer to Section 5.0 - SM-Plus™ RATINGS.

Minimum voltage rating of the protection device should be 250 Vac for 120/208/240 Vac and 208/240 Vac rated drives, and 600 Vac for 400/480 Vac and 480/590 Vac drives.

UL Class CC fast-acting, current limiting type fuses should be used when input fusing is required. Select fuses with low I<sup>2</sup>T values, rated at 200,000 AIC. Recommended fuses are Bussman KTK-R, JJN, and JJS. Similar fuses with equivalent ratings by other manufacturers may also be acceptable.

## 8.0 POWER WIRING

**⚠ DANGER** Hazard of electrical shock! Capacitors retain charge after power is removed. Disconnect incoming power and wait until the voltage between terminals B+ and B- is 0 VDC before servicing the drive.

Note drive input and output current ratings and check applicable electrical codes for required wire type and size, grounding requirements, over-current protection, and incoming power disconnect, before wiring the drive. Size conservatively to minimize voltage drop.

Strip off 0.20 to 0.25 inches (5 to 6mm) of insulation for input power, output power, and DC Bus wiring.

The input power, output power, and DC Bus terminals must be tightened to a torque of 4.0 to 4.5 lb-in. (0.5 Nm)

Input fusing and a power disconnect switch or contactor **MUST** be wired in series with terminals L1, L2, and L3 for three phase input models. For 208/240 Vac single phase input models, use terminals L1 and L2. For 120 Vac single phase input models, use terminals L1 and N. This disconnect must be used to power down the drive when servicing, or when the drive is not to be operated for a long period of time, but should not be used to start and stop the motor. **Repetitive cycling of a disconnect or input contactor (more than once every two minutes) may cause damage to the drive.**

### 8.1 WIRING FOR SINGLE PHASE OR THREE PHASE INPUT

If the drive is rated for 120/208/240 Vac single phase input, wire the input to terminals L1 and N for 120 Vac voltage, or wire to terminals L1 and L2 (do not wire to N) for 208/240 Vac input voltage. Refer to Section 9.0 - SM-Plus™ POWER WIRING DIAGRAM.

If the drive is rated for single and three phase input, wire to terminals L1 and L2 for single phase input, or wire to terminals L1, L2, and L3 for three phase input.

If the drive is rated for three phase input, wire the input to terminals L1, L2, and L3.

All three power output wires, from terminals T1, T2, and T3 to the motor, must be kept tightly bundled and run in a separate conduit away from all other power and control wiring.

It is not recommended to install contactors or disconnect switches between the drive and motor. Operating such devices while the drive is running can potentially cause damage to the drive's power components. If such a device is required, it should only be operated when the drive is in a STOP state. If there is potential for the device to be opened while the drive is running, the drive must be programmed for COAST to stop (see Parameter 4 - STOP METHOD), and an auxiliary contact on the device must be interlocked with the drive's run circuit. This will give the drive a stop command at the same time the device opens, and will not allow the drive to start again until the device is closed.

## 9.0 SM-Plus™ POWER WIRING DIAGRAM

THREE PHASE INPUT  
(WHERE APPLICABLE)

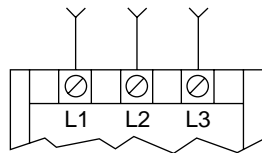

120 Vac SINGLE PHASE INPUT  
(WHERE APPLICABLE)

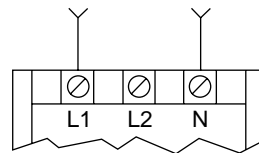

208/240 Vac SINGLE PHASE INPUT  
(WHERE APPLICABLE)

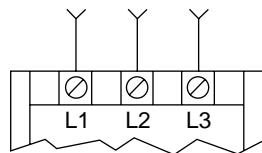

OUTPUT (ALL MODELS)

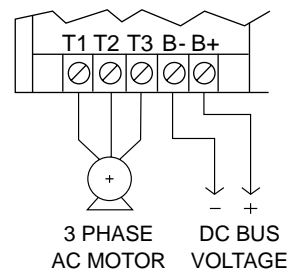

**⚠ WARNING** Do not connect incoming AC power to output terminals T1, T2, or T3. Severe damage to the drive will result.

### NOTES:

1. WIRE AND GROUND IN ACCORDANCE WITH NEC OR CEC, AND ALL APPLICABLE LOCAL CODES.
2. Motor wires **MUST** be run in a separate steel conduit away from control wiring and incoming AC power wiring.
3. Do not install contactors between the drive and the motor without consulting LEESON Electric for more information. Failure to do so may result in drive damage.
4. Use only UL and CSA listed and approved wire.
5. Minimum wire voltage ratings: 300 V for 120, 208 and 240 Vac systems, and 600 V for 400, 480, and 590 Vac systems.
6. Wire gauge must be based on a minimum of 125% of the rated input/output current of the drive, and a minimum 75° C insulation rating. Use copper wire only.
7. Strip off 0.20 to 0.25 inches (5 to 6mm) of insulation for input power, output power, and DC Bus wiring.



## 10.0 CONTROL WIRING

### 10.1 CONTROL WIRING VS. POWER WIRING

External control wiring **MUST** be run in a separate conduit away from all other input and output power wiring. If control wiring is not kept separate from power wiring, electrical noise may be generated on the control wiring that will cause erratic drive behavior. Use twisted wires or shielded cable grounded at the drive chassis **ONLY**. Recommended control wire is Belden 8760 (2-wire) or 8770 (3-wire), or equivalent.

Strip off 0.20 to 0.25 inches (5 to 6mm) of insulation for control wiring, and torque the terminals to 2 lb.-in. (0.2 Nm). Be careful not to overtorque the control terminals, as this will cause damage to the terminal strip. This is not covered under warranty and can only be repaired by replacing the control board.

### 10.2 TB-2: CIRCUIT COMMON

The TB-2 terminals are used as circuit common for the start/stop, forward/reverse, input select, local/remote, analog input, and analog output functions. There are three TB-2 terminals available on the terminal strip, and they are all internally connected to each other on the main control board. If necessary TB-2 may be connected to chassis ground.

**NOTE:** TB-2 must be connected to chassis ground when using serial communications.

### 10.3 SURGE SUPPRESSION ON RELAYS

Current and voltage surges and spikes in the coils of contactors, relays, solenoids, etc, near or connected to the drive, can cause erratic drive operation. Therefore, a snubber circuit should be used on coils associated with the drive. For AC coils, snubbers should consist of a resistor and a capacitor in series across the coil. For DC coils, a free-wheeling or flyback diode should be placed across the coil. Snubbers are typically available from the manufacturer of the device.

### 10.4 START/STOP CONTROL

There are various control schemes that allow for 2-wire and 3-wire Start/Stop circuits. Refer to the wiring diagrams in Section 11.0 - SM-Plus™ CONTROL WIRING DIAGRAMS.

### 10.5 SPEED REFERENCE SIGNALS

The drive allows for three analog speed reference inputs:

SPEED POT	Connect the wiper of a speed pot to terminal TB-5, and connect the high and low end leads to terminals TB-6 and TB-2, respectively. The speed pot can be 2.5k $\Omega$ up to 10k $\Omega$ .
0-10 VDC	Wire the positive to terminal TB-5 and the negative to terminal TB-2. TB-5 input impedance is 120 kilohms.
4-20 mA	Wire the positive to terminal TB-25 and the negative to terminal TB-2. TB-25 input impedance is 100 ohms.

## 10.6 SPEED REFERENCE SELECTION

If an analog speed reference input is used to control the drive speed, terminal TB-13A, 13B, or 13C (Parameter 10, 11, or 12) may be programmed as the input select for the desired analog input signal. When that TB-13 terminal is then closed to TB-2, the drive will follow the selected analog speed reference input.

If an analog speed reference input is not selected on the terminal strip using TB-13A, 13B, or 13C, speed control will default to STANDARD mode, which is governed by the setting of Parameter 05 - STANDARD SPEED SOURCE. The STANDARD SPEED SOURCE can be the ▲ and ▼ buttons on the front of the drive, PRESET SPEED #1 (Parameter 31), a 0-10 VDC signal, or a 4-20 mA signal.

### 0-10 VDC and 4-20 mA INPUT SIGNALS

TB-13A, TB-13B, and TB-13C can all be programmed to select a 0-10 VDC or 4-20 mA analog speed reference input.

### PRESET SPEEDS

TB-13A can be programmed to select PRESET SPEED #1, TB-13B to select PRESET SPEED #2, and TB-13C to select PRESET SPEED #3. There are a total of seven preset speeds, which are activated by different combinations of contact closures between TB-13A, 13B, 13C and TB-2. Refer to Parameters 31-37 in Section 15.0 - DESCRIPTION OF PARAMETERS.

### JOG

TB-13B can be programmed to select either JOG FORWARD or JOG REVERSE. The Jog speed is set by PRESET SPEED #2. Close TB-13B to TB-2 to JOG, and open the contact to STOP.

**⚠ WARNING** When operating in JOG mode, the STOP terminal (TB-1) and the STOP key (on the optional remote keypad) **WILL NOT** stop the drive. To stop the drive, remove the JOG command.

**⚠ WARNING** JOG REVERSE will operate the drive in reverse rotation even if ROTATION DIRECTION (Parameter 17) is set to FORWARD ONLY.

**NOTE:** If the drive is commanded to JOG while running, the drive will enter JOG mode and run at PRESET SPEED #2. When the JOG command is removed, the drive will STOP.

### MOTOR OPERATED POT (MOP) / FLOATING POINT CONTROL

TB-13B and TB-13C are used for this function, which controls the drive speed using contacts wired to the terminal strip. Program TB-13B for DECREASE FREQ (05), and program TB-13C for INCREASE FREQ (05). Closing TB-13B to TB-2 will cause the speed setpoint to decrease until the contact is opened. Closing TB-13C to TB-2 will cause the speed setpoint to increase until the contact is opened. The INCREASE FREQ function will only operate while the drive is running.

**NOTE:** If TB-13A, TB-13B, and TB-13C are all programmed to select speed references, and two or three of the terminals are closed to TB-2, the higher terminal has priority and will override the others. For example, if TB-13A is programmed to select 0-10 VDC, and TB-13C is programmed to select PRESET SPEED #3, closing both terminals to TB-2 will cause the drive to respond to PRESET SPEED #3, because TB-13C overrides TB-13A.

The exception to this is the MOP function, which requires the use of TB-13B and TB-13C. This leaves TB-13A to be used for some other function. If TB-13A is programmed for a speed reference, and TB-13A is closed to TB-2, TB-13A will override the MOP function.

### 10.7 ANALOG OUTPUT SIGNALS

Terminal TB-30 can provide a 0-10 VDC or a 2-10 VDC signal proportional to output frequency or load, and TB-31 can provide the same signals proportional to load only. The 2-10 VDC signal can be converted to a 4-20 mA signal using a resistor in series with the signal such that the total load resistance is 500 Ohms. Refer to Parameters 08 and 09 in Section 15.0 - DESCRIPTION OF PARAMETERS.

**NOTE:** These analog output signals cannot be used with “loop-powered” devices that derive power from a 4-20 mA signal.

### 10.8 DRIVE STATUS DIGITAL OUTPUTS

There are two open-collector outputs at terminals TB-14 and TB-15. The open-collector circuits are current-sinking types rated at 30 VDC and 50 mA maximum.

The open-collector outputs can be programmed to indicate any of the following: RUN, FAULT, INVERSE FAULT, FAULT LOCKOUT, AT SPEED, ABOVE PRESET SPEED #3, CURRENT LIMIT, AUTO SPEED MODE, and REVERSE. Refer to Parameters 06 and 13 in Section 15.0 - DESCRIPTION OF PARAMETERS.

The diagram below illustrates how the 12 VDC power supply at TB-11 can be used with the open-collector output to drive an external relay:

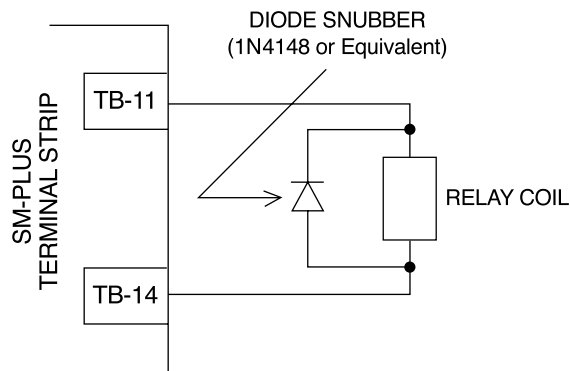

## 11.0 SM-Plus™ CONTROL WIRING DIAGRAMS

### 11.1 SM-Plus™ TERMINAL STRIP

Shown below is the terminal strip on the main control board, along with a brief description of the function of each terminal.

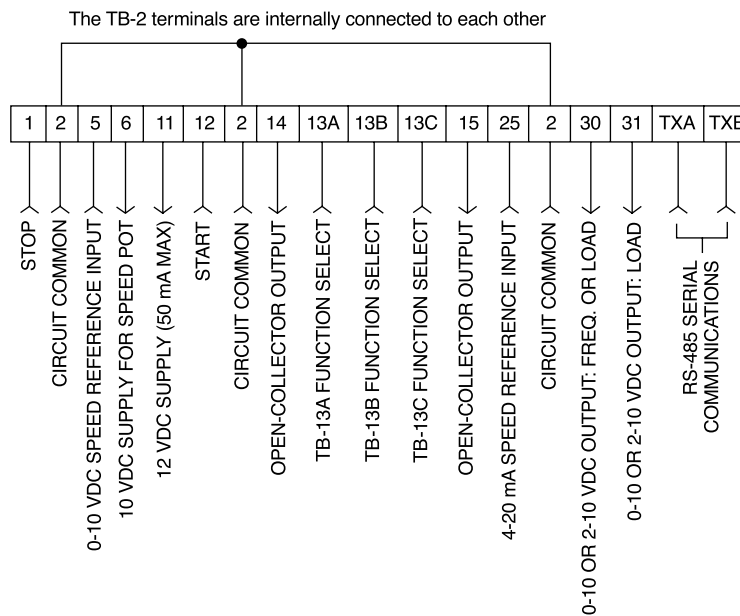

**NOTE:** The function of terminals TB-13A, TB-13B, TB-13C, TB-14, TB-15, TB-30, and TB-31 are dependent on the programming of certain parameters. Refer to Section 15.0 - DESCRIPTION OF PARAMETERS.

Additional information on operating the drive from the terminal strip can be found in Section 10.0. The following diagrams provide a quick reference to wire the drive for the most common configurations.

## 11.2 TWO-WIRE START/STOP CONTROL

Shown below is the wiring diagram for a typical two-wire start/stop control scheme, using one maintained contact (such as that from a PLC) for RUN and STOP commands.

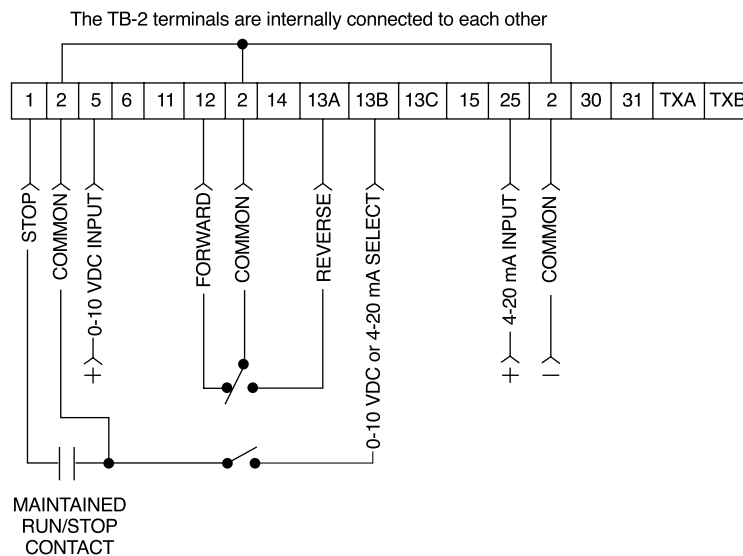

### NOTES:

1. Close TB-1 to TB-2 to RUN and open TB-1 to TB-2 to STOP.
2. If reverse direction is also required, ROTATION DIRECTION (Parameter 17) must be set to FORWARD AND REVERSE (02), and TB-13A (Parameter 10) must be set to START REVERSE (06). If reverse direction is not required, TB-12 must be wired directly to TB-2.
3. For 0-10 VDC or 4-20 mA speed control, use one of the following methods:
  1. Program one of the TB-13 terminals (13A, 13B, or 13C) for 0-10 VDC (02) or 4-20 mA (03). When that TB-13 terminal is closed to TB-2, the drive will respond to the selected speed reference signal. If that TB-13 terminal is not closed to TB-2, the drive will respond to the speed control source selected in Parameter 05 - STANDARD SPEED SOURCE. This method must be used if it is necessary to toggle between two speed sources.
  2. Program Parameter 05 - STANDARD SPEED SOURCE for 0-10 VDC (03) or 4-20 mA (04). This method is preferable if only one speed source is required, as this method leaves the TB-13 terminals free to be used for other functions.

### 11.3 ALTERNATE TWO-WIRE START/STOP CONTROL

Shown below is the wiring diagram for an alternate two-wire start/stop control scheme, using one maintained contact for RUN FORWARD and another maintained contact for RUN REVERSE.

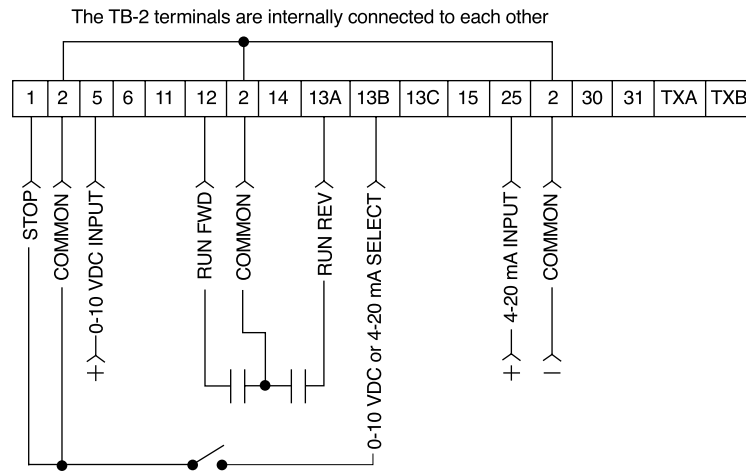

#### NOTES:

1. For this control scheme, TB-13A MUST be set to RUN REVERSE (05), even if REVERSE direction is not required. Refer to Parameter 10 - TB13A FUNCTION.
2. Close TB-12 to TB-2 to RUN and open TB-12 to TB-2 to STOP.
3. If reverse direction is also required, ROTATION DIRECTION (Parameter 17) must be set to FORWARD AND REVERSE (02). Close TB-13A to TB-2 to RUN in REVERSE, and open TB-13A to TB-2 to STOP. If TB-12 and TB-13A are closed to TB-2, the drive will STOP.
4. For 0-10 VDC or 4-20 mA speed control, use one of the following methods:
  1. Program one of the TB-13 terminals (13A, 13B, or 13C) for 0-10 VDC (02) or 4-20 mA (03). When that TB-13 terminal is closed to TB-2, the drive will respond to the selected speed reference signal. If that TB-13 terminal is not closed to TB-2, the drive will respond to the speed control source selected in Parameter 05 - STANDARD SPEED SOURCE. This method must be used if it is necessary to toggle between two speed sources.
  2. Program Parameter 05 - STANDARD SPEED SOURCE for 0-10 VDC (03) or 4-20 mA (04). This method is preferable if only one speed source is required, as this method leaves the TB-13 terminals free to be used for other functions.

## 11.4 THREE-WIRE START/STOP CONTROL

Shown below is the wiring diagram for a typical three-wire start/stop control scheme, using momentary contacts (such as pushbuttons) for START and STOP commands.

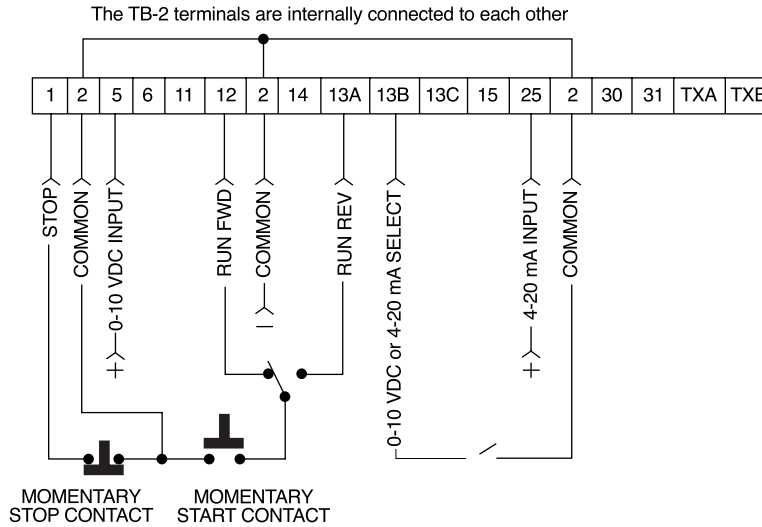

### NOTES:

1. Momentarily close TB-12 to TB-2 to START the drive, and momentarily open TB-1 to TB-2 to STOP the drive.
2. If reverse direction is also required, ROTATION DIRECTION (Parameter 17) must be set to FORWARD AND REVERSE (02), and TB-13A (Parameter 10) must be set to START REVERSE (06). If the FWD/REV switch is changed while the drive is running, the drive will not change direction until the START button is pushed. If reverse direction is not required, the other side of the START pushbutton must be wired directly to TB-12.
3. For 0-10 VDC or 4-20 mA speed control, use one of the following methods:
  1. Program one of the TB-13 terminals (13A, 13B, or 13C) for 0-10 VDC (02) or 4-20 mA (03). When that TB-13 terminal is closed to TB-2, the drive will respond to the selected speed reference signal. If that TB-13 terminal is not closed to TB-2, the drive will respond to the speed control source selected in Parameter 05 - STANDARD SPEED SOURCE. This method must be used if it is necessary to toggle between two speed sources.
  2. Program Parameter 05 - STANDARD SPEED SOURCE for 0-10 VDC (03) or 4-20 mA (04). This method is preferable if only one speed source is required, as this method leaves the TB-13 terminals free to be used for other functions.

## 11.5 SPEED POT AND PRESET SPEED CONTROL

Shown below is the wiring for SPEED POT and/or PRESET SPEED control, and either a two-wire or three-wire start/stop circuit:

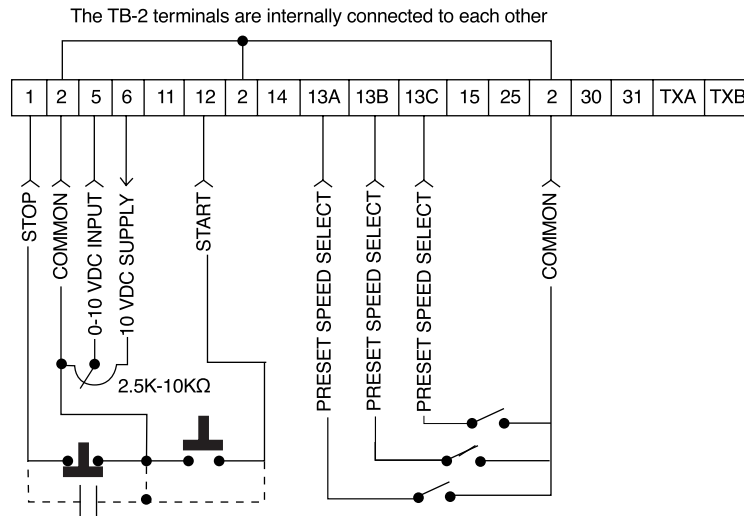

### NOTES:

1. Program the PRESET SPEEDS (Parameters 31-37) to the desired values.
2. Program TB-13A (Parameter 10) to PRESET SPEED #1 (04). TB-13B (parameter 11) to PRESET SPEED #2 (04), and TB-13C (Parameter 12) to PRESET SPEED #3 (04). To select a preset speed, close the appropriate TB-13 terminal(s) to TB-2 (refer to Parameters 31-37 for the Preset Speed Activation table).
3. If reverse rotation is also required, TB-13A cannot be used as a PRESET SPEED SELECT. TB-13A must be programmed to select RUN REVERSE (05) or START REVERSE (06), leaving only TB-13B and TB-13C to select preset speeds.
4. For speed pot control, program Parameter 05 - STANDARD SPEED SOURCE for 0-10 VDC (03). If none of the preset speeds are selected (all of the TB-13 terminals are open), the drive will respond to the speed pot.



## 12.0 INITIAL POWER UP AND MOTOR ROTATION

**⚠ WARNING** DO NOT connect incoming AC power to output terminals T1, T2, and T3! Severe damage to the drive will result. Do not continuously cycle input power to the drive more than once every two minutes. Damage to the drive will result.

**⚠ DANGER** Hazard of electrical shock! Wait three minutes after disconnecting incoming power before servicing drive. Capacitors retain charge after power is removed.

**⚠ WARNING** Severe damage to the drive can result if it is operated after a long period of storage or inactivity without reforming the DC bus capacitors!

If input power has not been applied to the drive for a period of time exceeding three years (due to storage, etc), the electrolytic DC bus capacitors within the drive can change internally, resulting in excessive leakage current. This can result in premature failure of the capacitors if the drive is operated after such a long period of inactivity or storage.

**In order to reform the capacitors and prepare the drive for operation after a long period of inactivity, apply input power to the drive for 8 hours prior to actually operating the motor.**

Before attempting to operate the drive, motor, and driven equipment, be sure all procedures pertaining to installation and wiring have been properly followed.

Disconnect the driven load from the motor. Verify that the drive input terminals (L1, L2, and L3) are wired to the proper input voltage per the nameplate rating of the drive.

Energize the incoming power line. The LED display will flash a three digit number (312 in the example below) that identifies the parameter version contained in the drive. The display should then read “- - -”, which indicates that the drive is in a STOP condition. This is shown below:

Apply input power

Display flashes parameter version (300-399)

Display then reads “- - -”

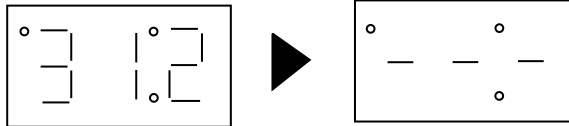

Follow the procedure below to check the motor rotation. This procedure assumes that the drive has been powered up for the first time, and that none of the parameters have been changed.

1. Use the ▼ button to decrease the speed setpoint to 00.0 Hz. The left decimal point will illuminate as the speed setpoint is decreased. If the ▼ button is held down, the speed setpoint will decrease by tenths of Hz until the next whole Hz is reached, and then it will decrease by one Hz increments. Otherwise, each push of the ▼ button will decrease the speed setpoint by a tenth of a Hz.

Once 00.0 Hz is reached, the display will toggle between “00.0” and “- -”, which indicates that the drive is in a STOP condition with a speed setpoint of 00.0 Hz.

2. Give the drive a START command. This can be done using one of several wiring methods described in Section 11.0 - SM-Plus™ CONTROL WIRING DIAGRAMS. Once the START command is issued, the display will read “00.0”, indicating that the drive is in a RUN condition with a speed setpoint of 00.0 Hz.
3. Use the ▲ button to increase the speed setpoint until the motor starts to rotate. The left decimal point will light as the speed setpoint is increased. If the ▲ button is held down, the speed setpoint will increase by tenths of Hz until the next whole Hz is reached, and then it will increase by one Hz increments. Otherwise, each push of the button will increase the speed setpoint by a tenth of a Hz.
4. If the motor is rotating in the wrong direction, give the drive a STOP command and remove power from the drive. Wait three minutes for the bus capacitors to discharge, and swap any two of the motor wires connected to T1, T2, and T3.

**NOTE:** The drive is phase insensitive with respect to incoming line voltage. This means that the drive will operate with any phase sequence of the incoming three phase voltage. Therefore, to change the motor rotation, the phases must be swapped at the drive output terminals or at the motor.

### 13.0 PROGRAMMING THE SM-Plus™ DRIVE

The drive may be programmed by one of three methods: using the three buttons and 3-digit LED display on the front of the display, programming the Electronic Programming Module (EPM) using the optional EPM Programmer, and through a serial link using serial communications. This section describes programming the drive using the buttons and display, which are shown below:



To enter the PROGRAM mode to access the parameters, press the **Mode** button. This will activate the PASSWORD prompt (if the password has not been disabled). The display will read “00” and the upper right-hand decimal point will be blinking, as shown below:

Press **Mode**

Display reads “00”

Upper right decimal point blinks

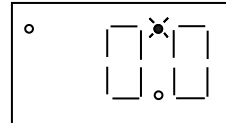

Use the ▲ and ▼ buttons to scroll to the password value (the factory default password is “225”) and press the **Mode** button. Once the correct password value is entered, the display will read “P01”, which indicates that the PROGRAM mode has been accessed at the beginning of the parameter menu (P01 is the first parameter). This is shown below:

Use ▲ and ▼ to scroll to the password value

Press **Mode** to enter password

Parameter menu is accessed at the first parameter

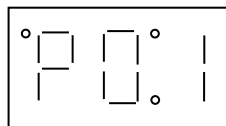
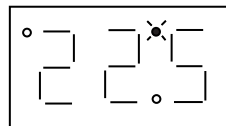

**NOTE:** If the display flashes “Er”, the password was incorrect, and the process to enter the password must be repeated.

Use the ▲ and ▼ buttons to scroll to the desired parameter number. In the example below, Parameter 19 is being displayed, which is the ACCELERATION TIME of the drive:

Use ▲ and ▼ to scroll to the desired parameter number (the example is Parameter 19 - ACCELERATION TIME)

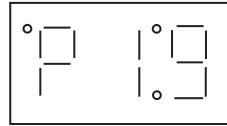

Once the desired parameter number is found, press the **Mode** button to display the present parameter setting. The upper right-hand decimal point will begin blinking, indicating that the present parameter setting is being displayed, and that it can be changed by using the ▲ and ▼ buttons.

Press **Mode** to display present parameter setting (example setting is 20.0)

Upper right decimal point blinks

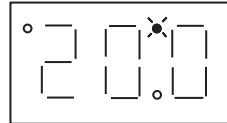

Use ▲ and ▼ to change setting (example setting changed to 30.0)

Press **Mode** to store new setting



Pressing the **Mode** will store the new setting and also exit the PROGRAM mode. To change another parameter, press the **Mode** key again to re-enter the PROGRAM mode (the parameter menu will be accessed at the parameter that was last viewed or changed before exiting). If the **Mode** key is pressed within two minutes of exiting the PROGRAM mode, the password is not required access the parameters. After two minutes, the password must be entered in order to access the parameters again.

### 13.1 SETTING VALUES IN TENTHS OF UNITS ABOVE 100

Parameter settings and the keypad speed command can always be adjusted in tenths of unit increments from 0.0 to 99.9. Above 100 however, values can be set in whole units or tenths of units, depending on the setting of Parameter 16 - UNITS EDITING.

If Parameter 16 - UNITS EDITING is set to WHOLE UNITS (02), parameter values and the keypad speed command can only be adjusted by whole unit increments above 100. For example, Parameter 19 - ACCELERATION TIME could not be set to 243.7 seconds. It could only be set to 243 or 244 seconds. Likewise, the keypad speed command (set using the ▲ and ▼ buttons) could not be set to 113.4 Hz. It could only be set to 113 or 114 Hz.

If, however, Parameter 16 - UNITS EDITING is set to TENTHS OF UNITS (01), parameter values and the keypad speed command can be adjusted in tenths of unit increments up to a value of 1000 (above 1000, whole unit increments only). Each push of the ▲ or ▼ button will adjust the value by one tenth of a unit. If the ▲ or ▼ button is pressed and held, the value will increment by tenths of units until the next whole unit is reached, and then the value will increment by whole units.

When a value above 100 is being adjusted by tenths of units, the value is shifted to the left by one digit so that the tenths portion of the value can be displayed. This results in the first digit (reading from left to right) of the value disappearing from the display. Also, the lower decimal point will blink to indicate that the actual value is above 100. Once the value is no longer being adjusted, the value will shift back to the right and the tenths portion of the value will disappear.

In the example below, Parameter 19 - ACCELERATION TIME is presently set to 243.0 seconds, and is being increased to 243.7 seconds.

Go to Parameter 19 and press **Mode**  
to see present setting ("243" seconds)

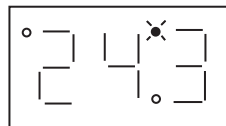

Upper right decimal point blinks

Press ▲ button to see tenths portion

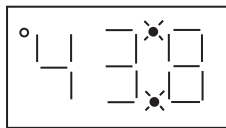

Value shifts to the left ("2" disappears)

Upper right decimal point and lower decimal point blink

Press ▲ button to scroll up to "43.7"

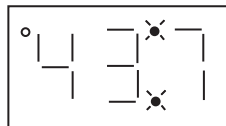

Press **Mode** to store new value

## 13.2 ELECTRONIC PROGRAMMING MODULE (EPM)

Every SM-Plus™ drive has an Electronic Programming Module (EPM) installed on the main control board. The EPM stores the user's parameter settings and special OEM default settings (if programmed). The EPM is removable, allowing it to be installed in another drive for quick set-up. For example, if a drive is being replaced with a new one, the EPM can be taken out of the first drive and installed in the new drive. Downtime is minimized because the new drive does not require programming - it is ready to run when the EPM is installed.

The SM-Plus™ drive contains two or three sets of parameter values, depending on whether the drive has been programmed with optional OEM default settings. The first set of values is the factory default settings, which are permanently stored on the main control board and cannot be changed. The second set of values is the user settings, which are stored in the EPM. When the drive leaves the factory, the user settings are the same as the factory default settings, but the user settings can be changed to configure the drive for a particular application. The optional third set of values is the OEM default settings, which are also stored in the EPM. OEM default settings are typically used in cases where many drives are used for the same application, which requires that all of the drives have the same parameter settings. The OEM default settings cannot be changed without the optional EPM Programmer. The drive can be programmed to operate according to the user settings or the OEM default settings (see Parameter 48 in Section 15.0).

**NOTE:** The drive will not operate without the EPM installed, The drive will display "F1" if the EPM is missing or damaged.

 **WARNING** Do not remove the EPM while power is applied to the drive. Damage to the EPM and/or drive may result.

An EPM Programmer is available as an option from LEESON Electric, which has the ability to quickly and easily program many SM-Plus™ drives for the same configuration. Once a "master" EPM is programmed with the desired parameter settings, the EPM Programmer can copy those setting to other EPMs, allowing many drives to be configured very quickly. Please consult the EPM Programmer Instruction Manual or contact the factory for more information.

If the OEM settings in the EPM become corrupted, the drive will operate normally, until an attempt is made to perform a RESET OEM using Parameter 48 - PROGRAM SELECTION. The drive will then flash "GF" to indicate that the OEM settings are no longer valid. This will require that the EPM be re-programmed using the optional EPM Programmer.

If the OEM settings and the user settings are both corrupted, the drive will display "GF" immediately and the drive will require a RESET 60 or RESET 50 using Parameter 48 - PROGRAM SELECTION. Once the RESET is performed, the parameters can then be programmed individually to match the OEM default settings. This will allow the drive to operate as if it were in OEM mode, even though it is actually in USER mode. Refer to Parameter 48 in Section 15.0 - DESCRIPTION OF PARAMETERS.

**NOTE:** The drive will also display "GF" if a RESET OEM or OPERATE WITH OEM SETTINGS is attempted when the drive is not equipped with the OEM default option.

## 14.0 PARAMETER MENU

NO.	PARAMETER NAME	RANGE OF ADJUSTMENT	FACTORY DEFAULT (NOTE 1)
01	LINE VOLTAGE	HIGH (01), LOW (02)	HIGH (01)
02	CARRIER FREQUENCY	4kHz (01), 6kHz (02), 8kHz (03), 10 kHz (04)	6 kHz (02)
03	START METHOD	NORMAL (01), START ON POWER UP (02), START WITH DC BRAKE (03), AUTO RESTART WITH DC BRAKE (04), FLYING RESTART 1 (05.), FLYING RESTART 2 (06), FLYING RESTART 3 (07)	NORMAL (01)
04	STOP METHOD	COAST (01), COAST WITH DC BRAKE (02), RAMP (03), RAMP WITH DC BRAKE (04)	COAST (01)
05	STANDARD SPEED SOURCE	KEYPAD (01), PRESET #1 (02), 0-10 VDC (03), 4-20 mA (04)	KEYPAD (01)
06 13	TB-14 OUTPUT TB-15 OUTPUT	NONE (01), RUN (02) ,FAULT (03), INVERSE FAULT (04), FAULT LOCKOUT (05), AT SET SPEED (06), ABOVE PRESET #3 (07), CURRENT LIMIT (08), AUTO SPEED (09), REVERSE (10)	NONE (01) NONE (01)
08	TB-30 OUTPUT	NONE (01), 0-10 VDC FREQ (02), 2-10 VDC FREQ (03), 0-10 VDC LOAD (04), 2-10 VDC LOAD (05)	NONE (01)
09	TB-31 OUTPUT	NONE (01), 0-10 VDC LOAD (02), 2-10 VDC LOAD (03), DYNAMIC BRAKING (04)	NONE (01)
10	TB-13A FUNCTION SELECT	NONE (01), 0-10 VDC(02), 4-20mA (03), PRESET SPEED #1 (04), RUN REVERSE (05), START REVERSE (06), EXTERNAL FAULT (07), REMOTE KEYPAD (08), DB FAULT (09), AUXILIARY STOP (10), ACCEL/DECCEL #2 (11)	NONE (01)
11	TB-13B FUNCTION SELECT	NONE (01), 0-10 VDC (02), 4-20mA (03), PRESET SPEED #2 (04), DECREASE FREQ (05), JOG FORWARD (06), JOG REVERSE (07), AUXILIARY STOP (08)	NONE (01)

**NOTE 1:** Factory defaults are shown for a 60 Hz base frequency. See Parameter 48 for 50 Hz base frequency.

PARAMETER MENU (cont)

NO.	PARAMETER NAME	RANGE OF ADJUSTMENT	FACTORY DEFAULT (NOTE 1)
12	TB-13C FUNCTION SELECT	NONE (01), 0-10 VDC (02), 4-20mA (03), PRESET SPEED #3 (04), INCREASE FREQ (05), EXTERNAL FAULT (06), REMOTE KEYPAD (07), DB FAULT (08), ACCEL/DECEL #2 (09)	NONE (01)
13	TB-15 OUTPUT	(SEE PARAMETER 6 - TB-14 OUTPUT)	NONE (01)
14	CONTROL	TERMINAL STRIP ONLY (01), REMOTE KEYPAD ONLY (02), TERMINAL STRIP OR REMOTE KEYPAD (03)	TERMINAL STRIP ONLY (01)
15	SERIAL LINK	DISABLE (01), 9600, 8, N, 2 WITH TIMER (02), 9600, 8, N, 2 WITHOUT TIMER (03), 9600, 8, 3, 1 WITH TIMER (04), 9600, 8, E, 1 WITHOUT TIMER (05), 9600, 8, O, 1 WITH TIMER (06), 9600, 8, O, 1 WITHOUT TIMER (07)	9600, 8, N, 2 (02)
16	UNITS EDITING	TENTHS OF UNITS (01), WHOLE UNITS (02)	WHOLE UNITS (02)
17	ROTATION	FORWARD ONLY (01), FORWARD AND REVERSE (02)	FORWARD ONLY (01)
19	ACCELERATION TIME	0.1 - 3600.0 SEC	20.0 SEC
20	DECELERATION TIME	0.1 - 3600.0 SEC	20.0 SEC
21	DC BRAKE TIME	0.0 - 3600.0 SEC	0.0 SEC
22	DC BRAKE VOLTAGE	0.0 - 30.0 %	0.0 %
23	MINIMUM FREQUENCY	0.0 - MAXIMUM FREQUENCY	0.0 Hz
24	MAXIMUM FREQUENCY	MINIMUM FREQ - 240.0 Hz (NOTE W)	60.0 Hz
25	CURRENT LIMIT	30 - 180 % (NOTE 3)	180 %
26	MOTOR OVERLOAD	30 - 100 %	100 %

**NOTE 1:** Factory defaults are shown for a 60 Hz base frequency. See Parameter 48 for 50 Hz base frequency.

**NOTE 2:** Maximum setting is 999.9 Hz on drives with High Output Frequency option. Consult the factory.

**NOTE 3:** If LINE VOLTAGE is set to LOW, maximum setting is 150%.



**PARAMETER MENU** (cont)

<b>NO.</b>	<b>PARAMETER NAME</b>	<b>RANGE OF ADJUSTMENT</b>	<b>FACTORY DEFAULT (NOTE 1)</b>
27	BASE FREQUENCY	25.0 - 500.0 Hz (NOTE 4)	60.0 Hz
28	FIXED BOOST	0.0 - 30.0 %	1.0 %
29	ACCEL BOOST	0.0 - 20.0 %	0.0 %
30	SLIP COMPENSATION	0.0 - 5.0 %	0.0 %
31-37	PRESET SPEEDS	0.0 - MAXIMUM FREQUENCY	0.0 Hz
38	SKIP BANDWIDTH	0.0 - 10.0 Hz	0.0 Hz
39	SPEED SCALING	0.0 - 6500.0	0.0
40	FREQUENCY SCALING	3.0 -2 000.0 Hz	60.0 Hz
41	LOAD SCALING	10 - 200 %	200 %
42	ACCEL / DECEL #2	0.1 - 3600.0 SEC	20.0 SEC
43	SERIAL ADDRESS	1 - 247	1
44	PASSWORD	000 - 999	225
47	CLEAR HISTORY	MAINTAIN (01), CLEAR (02)	MAINTAIN (01)
48	PROGRAM SELECTION	USER SETTINGS (01), OEM SETTINGS (02), RESET OEM (03), RESET 60 (04), RESET 50 (05), TRANSLATE (06)	USER SETTINGS (01)
50	FAULT HISTORY	(VIEW - ONLY)	(N/A)
51	SOFTWARE CODE	(VIEW - ONLY)	(N/A)
52	DC BUS VOLTAGE	(VIEW - ONLY)	(N/A)
53	MOTOR VOLTAGE	(VIEW - ONLY)	(N/A)
54	LOAD	(VIEW - ONLY)	(N/A)
55	0 - 10 VDC INPUT	(VIEW - ONLY)	(N/A)
56	4-20 mA INPUT	(VIEW - ONLY)	(N/A)
57	TB STRIP STATUS	(VIEW - ONLY)	(N/A)
58	KEYPAD STATUS	(VIEW - ONLY)	(N/A)
59	TB-30 OUTPUT	(VIEW - ONLY)	(N/A)
60	TB-31 OUTPUT	(VIEW - ONLY)	(N/A)

**NOTE 1:** Factory defaults are shown for a 60 Hz base frequency. See Parameter 48 for 50 Hz base frequency.

**NOTE 4:** Maximum setting is 1300.0 Hz (factory default is 999.9) on drives with High Output Frequency option. Consult the factory.

## 15.0 DESCRIPTION OF PARAMETERS

### P01 LINE VOLTAGE SELECTION

This calibrates the drive for the actual applied input voltage, and can be set to HIGH (01) or LOW (02). Refer to the table below for the proper setting depending on the input voltage.

RATED INPUT VOLTAGE	INPUT PHASE	APPLIED INPUT VOLTAGE	PARAMETER SETTING
120/208/240 Vac	1 1	110 - 120 Vac or 220 - 240 Vac 200 - 208 Vac	HIGH (01) LOW (02)
208 / 240 Vac	1 or 3 1 or 3	220 - 240 Vac 220 - 203 Vac	HIGH (01) LOW (02)
208 / 240 Vac	3 3	220 - 240 Vac 200 - 208 Vac	HIGH (01) LOW (02)
400 / 480 Vac	3 3	440 - 480 Vac 380 - 415 Vac	HIGH (01) LOW (02)
480 / 590 Vac	3 3	575 - 600 Vac 460 - 480 Vac	HIGH (01) LOW (02)

**NOTE:** If this parameter is changed while the drive is running, the new value will not take effect until the drive is stopped.

### P02 CARRIER FREQUENCY

This sets the switching rate of the output IGBT's. Increasing the carrier frequency will result in less audible motor noise. Available settings are: 4 kHz, 6 kHz, 8 kHz, and 10 kHz.

PARAMETER SETTING	CARRIER FREQUENCY	MAXIMUM OUTPUT FREQUENCY (NOTE 1)	AMBIENT OR OUTPUT DERATE (NOTE 2)
01	4 kHz	240.0 Hz (400.0 Hz)	50 C or 100 %
02	6 kHz	240.0 Hz (600.0 Hz)	50 C or 100 %
03	8 kHz	240.0 Hz (999.9 Hz)	43 C or 92 %
04	10 kHz	240.0 Hz (999.9 Hz)	35 C or 82 %

**NOTE 1:** For drives with the High Output Frequency option, the carrier frequency also determines the maximum output frequency (shown in parenthesis).

**NOTE 2:** The SM-Plus™ drive is fully rated up to 6 kHz carrier frequency. If the 8 kHz or 10 kHz carrier frequency is selected, the drive's ambient temperature rating OR output current rating must be derated to the value shown in the table above.

**NOTE 3:** If this parameter is changed while the drive is running, the change will not take effect until the drive is stopped. Therefore, the allowable maximum frequency for drives with the High Output Frequency option (see NOTE 1) will not change if the carrier frequency is changed while the drive is running.

### **P03      START METHOD**

**⚠ DANGER** Automatic starting of equipment may cause damage to equipment and / or injury to personnel! Automatic start should only be used on equipment that is inaccessible to personnel.

- 01      NORMAL: The drive will start when the appropriate contact is closed on the terminal strip, or by pressing the START key on the optional remote keypad. See Parameter 14.
- 02      START ON POWER UP: The drive will automatically start upon application of input power.
- 03      START WITH DC BRAKE: When a START command is given, the drive will apply DC BRAKE VOLTAGE (Parameter 22) for the duration of DC BRAKE TIME (Parameter 21) prior to starting the motor to ensure that the motor is not turning.
- 04      AUTO RESTART WITH DC BRAKING: Upon a START command, after a fault, or upon application of power, the drive will apply DC BRAKE VOLTAGE (Parameter 22) for the duration of DC BRAKE TIME (Parameter 21) prior to starting (or restarting) the motor.
- 05      FLYING RESTART 1: LOW performance. Slowest synchronization and lowest current level. This setting results in the smoothest synchronization.
- 06      FLYING RESTART 2: MEDIUM performance. Faster synchronization and higher current level. This setting allows faster synchronization while retaining smoothness.
- 07      FLYING RESTART 3: HIGH performance. Fastest synchronization and highest current level. This setting allows the fastest synchronization, but sacrifices smoothness.

The FLYING RESTART 1 - 3 settings allow the drive to start into a spinning load after a fault or upon application of input power. They differ in the time required to find the motor and the amount of current required to synchronize with it. The faster the drive attempts to find the motor, the more current is required.

When programmed for auto-restart, the drive will attempt three restarts after a fault. The interval between restart attempts is 15 seconds for setting 04, and 2 seconds for settings 05, 06 and 07. During the interval between restart attempts, the display will read "SP" to indicate Start Pending. If all three restart attempts fail, the drive will trip into FAULT LOCKOUT (displayed "LC") and require a manual reset. Refer to Section 16.0 - TROUBLESHOOTING.

**NOTE:** Settings 02 and 04 - 07 require a two-wire start/stop circuit to operate. The RUN contact must remain closed for the power-up start and auto-restart functions to operate.

**P04 STOP METHOD**

- 01 COAST TO STOP: When a STOP command is given, the drive shuts off the output to the motor, allowing it to coast freely to a stop.
- 02 COAST WITH DC BRAKE: When a stop command is given, the drive will activate DC braking (after a delay of up to 2 seconds, depending on frequency) to help decelerate the load. Refer to Parameters: 21 - DC BRAKE TIME, and 22 - DC BRAKE VOLTAGE.
- 03 RAMP TO STOP: When a stop command is given, the drive will decelerate the motor to a stop at the rate determined by Parameter 20 - DECELERATION TIME.
- 04 RAMP WITH DC BRAKE: When a stop command is given, the drive will decelerate the motor down to 0.2 Hz (at the rate set by Parameter 20 - DECELERATION TIME) and then activate DC braking according to the settings of Parameters 21 - DC BRAKE TIME and 22 - DC BRAKE VOLTAGE. This is used to bring the load to a final stop, as the motor may still be turning slightly after the drive stops.

**P05 STANDARD SPEED SOURCE**

This selects the speed reference source when the drive is in STANDARD speed mode. The following speed reference can be selected.

- 01 KEYPAD: Use the ▲ and ▼ buttons to scroll to the desired speed.
- 02 PRESET SPEED #1: The drive will operate at the frequency set into Parameter 31.
- 03 0 - 10 VDC: The drive will respond to a 0 - 10 VDC signal wired to TB-2 and TB-5.
- 04 4 - 20 mA: The drive will respond to a 4-20 mA signal wired to TB-2 and TB-25.

**P06 TB-14 OPEN COLLECTOR OUTPUT**

This selects the status indication for the open-collector output at TB-14. The terms “open” and “close” refer to the state of the internal transistor that activates the circuit. When the transistor is “closed”, TB-14 is at the same potential as TB-2, allowing current to flow.

- 01 NONE: Disables the open-collector output.
- 02 RUN: Closes upon a START command. Opens if the drive is in a STOP state, the drive faults, or input power is removed. DC braking is considered a STOP state.
- 03 FAULT: Closes if there is no fault condition. Opens if the drive faults, or input power is removed.
- 04 INVERSE FAULT: Closes is the drive faults. Opens if there is no fault condition.
- 05 FAULT LOCKOUT: Closes when input power is applied. Opens if three restart attempts are unsuccessful, or if input power is removed.

- 06 AT SET SPEED: Closes if the drive is within  $\pm 0.5$  Hz of the speed setpoint.
- 07 ABOVE PRESET SPEED #3: Closes if the output frequency exceeds the PRESET SPEED #3 setting. Opens if the output frequency is equal to or less than PRESET SPEED #3 (Parameter 33).
- 08 CURRENT LIMIT: Closes if the output current exceeds the CURRENT LIMIT setting. Opens if the output current is equal to or less than CURRENT LIMIT (see Parameter 25).
- 09 AUTOMATIC SPEED MODE: Closes if an AUTOMATIC (terminal strip) speed reference is active. Opens if a STANDARD (Parameter 5) speed reference is active.
- 10 REVERSE: Closes when reverse rotation is active. Opens when forward rotation is active. (see Parameter 17 - ROTATION DIRECTION).

**P08 TB-30 ANALOG OUTPUT**

Terminal TB-30 can be used as an analog output proportional to either output frequency or load. FREQUENCY SCALING (Parameter 40) or LOAD SCALING (Parameter 41) can be used to scale the output signal.

- 01 NONE
- 02 0-10 VDC FREQ
- 03 2-10 VDC FREQ
- 04 0-10 VDC LOAD
- 05 2-10 VDC LOAD

**NOTE:** The 2-10 VDC signal can be converted to a 4-20 mA signal by connecting a resistor in series with the signal such that the total load resistance is 500 Ohms. However, this output cannot be used with devices that derive power from a 4-20 mA signal.

**P09 TB-31 ANALOG OUTPUT**

Terminal TB-31 can be used as an analog output proportional to load, or as the control signal to activate the optional external Dynamic Braking module. LOAD SCALING (Parameter 41) can be used to scale the output signal when TB-31 is used as an analog output proportional to load.

- 01 NONE
- 02 0-10 VDC LOAD
- 03 2-10 VDC LOAD
- 04 DYNAMIC BRAKING: TB-31 becomes the “trigger” that activates the optional external Dynamic Braking module. Refer to the instructions included with the Dynamic Braking option.

**NOTE:** The 2-10 VDC signal can be converted to a 4-20 mA signal by connecting a resistor in series with the signal such that the total load resistance is 500 Ohms. However, this output cannot be used with devices that derive power from a 4-20 mA signal.

#### **P10 TB-13A FUNCTION SELECT**

This selects the function of terminal TB-13A. Closing TB-13A to TB-2 (or opening in the case of settings 7 and 10) activates the selected function. The following functions can be selected:

- 01 NONE: Disables the TB-13A function.
- 02 0-10 VDC: Selects a 0-10 VDC signal (at TB-5) as the AUTO speed reference input.
- 03 4-20 mA: Selects a 4-20 mA signal (at TB-25) as the AUTO speed reference input.
- 04 PRESET SPEED #1: Selects PRESET SPEED #1 as the AUTO speed reference. The drive will operate at the frequency programmed into Parameter 31.
- 05 RUN REVERSE: Close TB-13A to TB-2 to RUN in the reverse direction, and open to STOP. This setting forces TB-12 to act as RUN FWD, requiring a maintained contact to RUN in the forward direction. TB-1 must be closed to TB-2 for this function to operate.
- 06 START REVERSE: Momentarily close TB-13A to TB-2 to START the drive in the reverse direction. Momentarily open TB-1 to TB-2 to STOP. This setting forces TB-12 to act as START FWD, requiring a momentary contact to START in the forward direction.
- 07 EXTERNAL FAULT: Sets TB-13A as a normally closed external fault input. If TB-13A is open with respect to TB-2, the drive will fault.
- 08 REMOTE KEYPAD: Selects the optional remote keypad as the control source. Refer to Parameter 14 - CONTROL.
- 09 DB FAULT: Sets TB-13A as a dynamic braking fault input when using the optional dynamic braking module. When this input is activated by the dynamic braking module, the drive will trip into a "dF" fault and the motor will coast to a stop. Refer to the manual included with the Dynamic Braking option.
- 10 AUXILIARY STOP: When TB-13A is opened with respect to TB-2, the drive will decelerate to a STOP (even if STOP METHOD is set to COAST) at the rate set into Parameter 42 - ACCEL/DECEL #2.
- 11 ACCEL/DECEL #2: Selects the acceleration and deceleration time programmed into Parameter 42 - ACCEL/DECEL #2.

**NOTE:** In order for the RUN REVERSE and START REVERSE function to operate, Parameter 17 - ROTATION DIRECTION must be set to FORWARD AND REVERSE (02).

#### **P11 TB-13B FUNCTION SELECT**

This selects the function of terminal TB-13B. Closing TB-13B to TB-2 (or opening in the case of setting 08) activates the selected function. The following functions can be selected:

- 01 NONE: Disables the TB-13B function.
- 02 0-10 VDC: Selects a 0-10 VDC signal (at TB-5) as the AUTO speed reference input.
- 03 4-20 mA: Selects a 4-20 mA signal (at TB-25) as the AUTO speed reference input.
- 04 PRESET SPEED #2: Selects PRESET SPEED #2 as the AUTO speed reference. The drive will operate at the frequency programmed into Parameter 32.
- 05 DECREASE FREQUENCY: Decreases the speed setpoint when using the MOP function. Refer to Section 10.6.
- 06 JOG FORWARD: Jog in the forward direction. In this mode, the drive will JOG at the speed programmed into Parameter 32 - PRESET SPEED #2.
- 07 JOG REVERSE - Jog in the reverse direction. In this mode, the drive will JOG at the speed programmed into Parameter 32 - PRESET SPEED #2.

**⚠ WARNING** When operating in JOG mode, the STOP terminal (TB-1), the AUXILIARY STOP function (see setting 08), and the STOP key on the optional remote keypad WILL NOT stop the drive. To stop the drive, remove the JOG command.

**⚠ WARNING** JOG REVERSE will operate the drive in reverse even if ROTATION DIRECTION (Parameter 17) is set to FORWARD ONLY.

- 08 AUXILIARY STOP: When TB-13B is opened with respect to TB-2, the drive will decelerate to a STOP (even if STOP METHOD is set to COAST) at the rate set into Parameter 42 - ACCEL/DECEL #2.

**NOTE:** If the drive is commanded to JOG when running, the drive will enter JOG mode and run at PRESET SPEED #2. When the JOG command is removed, the drive will STOP.

**P12 TB-13C FUNCTION SELECT**

This selects the function of terminal TB-13C. Closing TB-13C to TB-2 (or opening in the case of setting 06) activates the selected function. The following functions can be selected:

- 01 NONE: Disables the TB-13C function.
- 02 0-10 VDC: Selects a 0-10 VDC signal (at TB-5) as the AUTO speed reference input.
- 03 4-20 mA: Selects a 4-20 mA signal (at TB-25) as the AUTO speed reference input.
- 04 PRESET SPEED #3: Selects PRESET SPEED #3 as the AUTO speed reference. The drive will operate at the frequency programmed into Parameter 33.
- 05 INCREASE FREQUENCY: Increases the speed setpoint when using the MOP function. Refer to Section 10.6.

- 06 EXTERNAL FAULT: Sets TB-13C as a normally closed external fault input. If TB-13C is open with respect to TB-2, the drive will fault.
- 07 REMOTE KEYPAD: Selects the optional remote keypad as the control source. Refer to Parameter 14 - CONTROL.
- 08 DB FAULT: Sets TB-13C as a dynamic braking fault input when using the optional dynamic braking module. When this input is activated by the dynamic braking module, the drive will trip into a “dF” fault and the motor will coast to a stop. Refer to the manual included with the Dynamic Braking option.
- 09 ACCEL/DECEL #2: Selects the acceleration and deceleration time programmed into Parameter 42 - ACCEL/DECEL #2.

**P13 TB-15 OPEN COLLECTOR OUTPUT**

This selects the status indication for the open-collector output at TB-15, and has the same selections as Parameter 6 - TB-14 OPEN COLLECTOR OUTPUT.

**P14 CONTROL**

This selects the source of START/STOP and direction commands.

- 01 TERMINAL STRIP ONLY: The drive will only respond to START/STOP and direction commands from the terminal strip.
- 02 REMOTE KEYPAD ONLY: The drive will only respond to START/STOP and direction commands from the optional remote keypad.
- 03 TERMINAL STRIP OR REMOTE KEYPAD: Terminal TB-13A or TB-13C can be used to select terminal strip control or remote keypad control. See Parameters 10 and 12.

**NOTE:** This STOP button on the optional remote keypad is always active as long as the serial link remains intact.

**P15 SERIAL LINK**

This parameter configures the drive for serial communications. The options are listed by baud rate, number of data bits, parity, number of stop bits, and whether the watchdog timer is enabled or disabled.

The watchdog timer will stop the drive after 10 seconds of no serial activity to safeguard against a failed serial link. During set-up or troubleshooting, it may be useful to disable the watchdog timer, but it is not recommended to run normally without the watchdog timer.

**⚠ WARNING** Controlling the drive from the serial link without the watchdog timer could cause damage to equipment and/or injury to personnel!



- 01 DISABLED: Disables the serial link
- 02 9600, 8, N, 2- ENABLED WITH TIMER
- 03 9600, 8, N, 2- ENABLED WITHOUT TIMER
- 04 9600, 8, E, 1 - ENABLED WITH TIMER
- 05 9600,8,E,1 - ENABLED WITHOUT TIMER
- 06 9600, 8, O, 1 - ENABLED WITH TIMER
- 07 9600, 8, O, 1 - ENABLED WITHOUT TIMER

**P16 UNITS EDITING**

This allows parameter and keypad speed editing in whole units or tenths of units above 100. Below 100, the value can always be changed by tenths of units.

- 01 TENTHS OF UNITS: The value can always be changed by tenths of units (up to a value of 1000). If the ▲ or ▼ button is pressed and held, the value will change by tenths of units until the next whole unit is reached, and then the value will change by whole units. Refer to Section 13.1.
- 02 WHOLE UNITS: The value can be changed by tenths of units until 99.9 is reached. Above 99.9, the value will change in whole unit increments only. Below a value of 100, if the ▲ or ▼ button is pressed and held, the value will change by tenths of units until the next whole unit is reached, and then the value will change by whole units.

**P17 ROTATION DIRECTION**

- 01 FORWARD ONLY: The drive will only allow rotation in the forward direction. However, JOG REVERSE (see Parameter 11) will still operate even if FORWARD ONLY is selected.
- 02 FORWARD AND REVERSE: The drive will allow rotation in both directions.

**P19 ACCELERATION TIME**

This parameter sets the acceleration rate for all of the speed reference sources (keypad, speed pot, 4-20 mA, 0-10 VDC, jog, MOP, and preset speeds). This setting is the time to accelerate from 0 Hz to the BASE FREQUENCY (Parameter 27).

**P20 DECELERATION TIME**

This parameter sets the deceleration rate for all of the speed reference sources (keypad, speed pot, 4-20 mA, 0-10 VDC, jog MOP, and preset speeds). This setting is the time to decelerate from BASE FREQUENCY to 0 Hz.. If the drive is set for COAST TO STOP (setting 01 or 02 in Parameter 04), this parameter will have no effect when a STOP command is given.

**P21 DC BRAKE TIME**

This determines the length of time that the DC braking voltage is applied to the motor. The DC BRAKE TIME should be set to the lowest value that provides satisfactory operation in order to minimize motor heating.

## **P22 DC BRAKE VOLTAGE**

This sets the magnitude of the DC braking voltage, in percentage of the nominal DC Bus voltage (DC Bus = input AC voltage X 1.414). The point at which the DC braking is activated depends on the selected STOP METHOD (Parameter 04):

IF COAST WITH DC BRAKE is selected, the DC braking is activated after a time delay of up to 2 seconds, depending on the output frequency at the time of the STOP command. In this case, the DC braking is the only force acting to decelerate the load.

IF RAMP WITH DC BRAKE is selected, braking is activated when the output frequency reaches 0.2 Hz. In this case, the drive decelerates the load to a near stop and the DC braking is used to bring the load to a final stop.

## **P23 MINIMUM FREQUENCY**

This sets the minimum output frequency of the drive for all speed reference sources except the PRESET SPEEDS (Parameters 31-37).

When using a 0-10 VDC or 4-20 mA analog speed reference signal, this parameter also sets the drive speed that corresponds to the minimum analog input (0 VDC or 4 mA).

**NOTE:** If this parameter is changed while the drive is running, the new value will not take effect until the drive is stopped.

## **P24 MAXIMUM FREQUENCY**

This sets the maximum output frequency of the drive for all speed reference sources, and is used with MINIMUM FREQUENCY (Parameter 23) to define the operating range of the drive.

When using a 0-10 VDC or 4-20 mA analog speed reference signal, this parameter also sets the drive speed that corresponds to the maximum analog input (10 VDC or 20 mA).

**NOTE 1:** On drives equipped with the High Output Frequency option, this parameter can be set up to 999.9 Hz.

**NOTE 2:** If this parameter is changed while the drive is running, the new value will not take effect until the drive is stopped.

## **P25 CURRENT LIMIT**

This sets the maximum allowable output current of the drive. The maximum setting is either 180% or 150%, depending on whether LINE VOLTAGE SELECTION (Parameter 01) is set to HIGH or LOW.

The drive will enter current limit when the load demands more current than the CURRENT LIMIT setting. When this happens, the drive will reduce the output frequency in an attempt to reduce the output current. When the overload condition passes, the drive will accelerate the motor back up to the speed setpoint.

**P26 MOTOR OVERLOAD**

The SM-Plus™ is UL approved for solid state motor overload protection, and therefore does not require a separate thermal overload relay for single motor applications.

The drive contains an adjustable thermal overload circuit that protects the motor from excessive overcurrent. This circuit allows the drive to deliver up to 150% current for one minute. If the overload circuit “times out”, the drive will trip into an OVERLOAD fault (displayed as “PF”).

MOTOR OVERLOAD should be set to the ratio (in percent) of the motor current rating to the drive current rating in order to properly protect the motor. See the example below.

**Example:** A 3 HP, 480 Vac drive with a 4.8 Amp rating is operating a 2 HP motor with a current rating of 3.4 Amps. Dividing the motor current rating by the drive current rating yields 71% ( $3.4 / 4.8 = 0.71 = 71\%$ ), so this parameter should be set to 71%.

**P27 BASE FREQUENCY**

The BASE FREQUENCY determines the V/Hz ratio by setting the output frequency at which the drive will output full voltage to the motor. In most cases, the BASE FREQUENCY should be set to match the motor’s rated frequency.

**Example:** A 460 Vac, 60 Hz motor requires a V/Hz ratio of 7.67 ( $460 \text{ V} / 60 \text{ Hz} = 7.67 \text{ V/Hz}$ ) to produce full torque. Setting the BASE FREQUENCY to 60 Hz causes the drive to output full voltage (460 Vac) at 60 Hz, which yields the required 7.67 V/Hz. Output voltage is proportional to output frequency, so the 7.67 V/Hz ratio is maintained from 0 - 60 Hz, allowing the motor to produce full torque from 2 Hz (below 2 Hz there is less torque due to slip) up to 60 Hz.

**NOTE:** If this parameter is changed while the drive is running, the new value will not take effect until the drive is stopped.

**P28 FIXED BOOST**

FIXED BOOST increases starting torque by increasing the output voltage when operating below half of the base frequency, which increases the V/Hz ratio (see diagram below). For better out-of-the-box performance, SM-Plus™ drives are shipped with a setting that is different from the factory default, as seen in the table below. If a factory reset is performed, FIXED BOOST will default to 1.0%.

HP	FACTORY SETTING	HP	FACTORY SETTING
0.25 -1	5.3 %	7.5	2.7 %
1.5	4.4 %	10	2.4 %
2	4.4 %	15	2.2 %
3	3.6 %	20	2.0 %
5	3.0 %	25	1.8 %

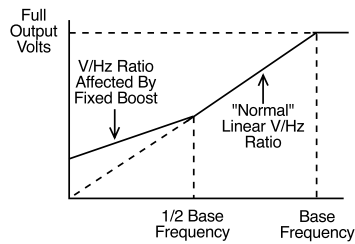

**P29 ACCELERATION BOOST**

ACCELERATION BOOST helps accelerate high-inertia loads. During acceleration, the output voltage is increased to increase motor torque. Once the motor reaches the new speed setpoint, the boost is turned off and the output voltage returns to the normal value.

**P30 SLIP COMPENSATION**

SLIP COMPENSATION is used to counteract changes in motor speed (slip) caused by changes in load. In a standard AC induction motor, the shaft speed decreases as load increases, and increases as load decreases. By increasing or decreasing the output frequency in response to an increasing or decreasing load, the slip is counteracted and speed is maintained. Most standard NEMA B motors have a 3% slip rating.

**P31 - P37 PRESET SPEED #1 - #7**

Preset speeds are activated by contact closures between TB-2 and TB-13A, 13B, and 13C. The TB-13 terminals must be programmed as preset speed selects using Parameters 10-12.

**NOTE 1:** Preset speeds can operate below the frequency defined by the minimum frequency parameter (Parameter 23). The range of adjustment for the preset speeds is from 0 Hz to the maximum frequency (Parameter 24).

Refer to the table below for activation of the preset speeds using the TB-13 terminals.

SPEED #	TB-13A	TB-13B	TB-13C
1	CLOSED	OPEN	OPEN
2	OPEN	CLOSED	OPEN
3	OPEN	OPEN	CLOSED
4	CLOSED	CLOSED	OPEN
5	CLOSED	OPEN	CLOSED
6	OPEN	CLOSED	CLOSED
7	CLOSED	CLOSED	CLOSED

**NOTE 2:** When a TB-13 terminal is programmed for a function other than a preset speed select, it is considered OPEN for the table above.

Preset Speed #6 and #7 can also be used as skip frequencies to restrict the drive from operating at frequencies that cause vibration in the system. See Parameter 38 below.

**P38 SKIP BANDWIDTH**

The SM-Plus™ drive has two skip frequencies that can be used to lock out critical frequencies that cause mechanical resonance in the system. Once SKIP BANDWIDTH is set to a value other than 0.0 Hz, the skip frequencies are enabled. When the skip frequency function is enabled, PRESET SPEED #6 and #7 are used as the skip frequencies. SKIP BANDWIDTH sets the range above the skip frequencies that the drive will not operate within.

**Example:** The critical frequency is 23 Hz, and it is desired to skip a frequency range of 3 Hz above and below the critical frequency (therefore the skip range is 20 to 26 Hz). PRESET SPEED #6 or #7 would be set to 20 Hz, and the SKIP BANDWIDTH would be set to 6.0 Hz.

If the drive is running at a speed below the skip range, and it is given a speed command that is within the skip range, the drive will accelerate to the start of the skip range (20 Hz in the example) and run at the speed until the speed command is greater than or equal to the “top” of the skip range. The drive will then accelerate through the skip range to the new speed. Likewise, if the drive is running at a speed above the skip range, and it is given a speed command that is within the skip range, the drive will decelerate to the “top” of the skip range (26 Hz in the example) and run at that speed until the speed command is less than or equal to the “bottom” of the skip range. The drive will then decelerate through the skip range to the new speed.

**NOTE:** PRESET SPEEDS #6 and #7 can still be used as preset speeds even if they are also being used as skip frequencies.

#### **P39      SPEED SCALING**

This scales the display to indicate speed or user units other than frequency. This parameter should be set to the desired display value when the drive output is 60 Hz. The highest setting is 6500, and the highest value that can be displayed is 6553.6.

**Example:** A machine produces 175 parts per hour when the motor is running at 60 Hz. Setting the SPEED SCALING to 175 will calibrate the drive’s display to read 175 when the motor is running at 60 Hz. This is a linear function, so at 30 Hz the display would read 87.5, and at 120 Hz, the display would read 350.

**NOTE:** If SPEED SCALING is set such that the maximum displayable value (6553.6) is exceeded, the display will flash “9999” to indicate that the value is out of range. For example, if SPEED SCALING is set to 6000, the drive will display 6000 when it is running at 60 Hz. If the speed is increased past 65.5 Hz (at 65.5 Hz, the scaled value would be 6550), the display will flash “9999” because a scaled value above 6553.6 cannot be displayed.

#### **P40      FREQUENCY SCALING**

This scales the analog output signal at TB-30 when it is configured for a frequency output. This setting is the output frequency that is indicated when the output signal measures 10 VDC.

Example: A 0-5 VDC signal is required to indicate 0-60 Hz. Setting this parameter to 120 Hz would yield 10 VDC at 120 Hz, and 5 VDC at 60 Hz. If the drive only operates up to 60 Hz, the output signal at TB-30 is limited to the desired 0-5 VDC.

#### **P41      LOAD SCALING**

This scales the analog output signal at TB-30 and /or TB-31 when they are configured for a load output. This setting is the load (in %) that is indicated when the output signal measures 10 VDC.

**Example:** A 0-10 VDC signal is required to indicate 0-150% load. Setting this parameter to 150% will yield 10 VDC at 150% load.

**P42 ACCEL / DECEL #2**

This parameter sets the second acceleration and deceleration rate of the drive. To activate this acceleration and deceleration rate, use terminal TB-13A, TB-13B or TB-13C. TB-13A and TB-13B can be set to AUXILIARY STOP which will cause the drive to decelerate to a stop according to the time programmed in this parameter. TB-13C can be set to ACCEL/DECEL #2, which causes the drive to accelerate and decelerate according to the time programmed in this parameter.

**P43 SERIAL ADDRESS**

If a serial link is being used to communicate with multiple drives, each drive must be given a different address (from 1 to 247) so that an individual drive in the network can be accessed.

**P44 PASSWORD**

This allows the PASSWORD to be changed to any number between 000 and 999. Setting PASSWORD to 000 disables the password function.

NOTE: The factory default password is 225.

**P47 CLEAR FAULT HISTORY**

- 01 MAINTAIN: Maintains the FAULT HISTORY (Parameter 50) entries for troubleshooting.
- 02 CLEAR: Erases the FAULT HISTORY (Parameter 50) entries.

**P48 PROGRAM SELECTION**

This is used to select whether the drive will operate according to the user settings or the optional OEM default settings, and to reset the parameters to default settings. Refer to Section 13.2.

- 01 OPERATE WITH USER SETTINGS: The drive will operate according to the users settings. Operation in USER mode allows the parameter values to be changed to suit any application.
- 02 OPERATE WITH OEM DEFAULTS: The drive will operate according to the optional OEM default settings, which configure the drive for a specific application. When operating in OEM mode, the parameter values can be viewed, but not changed. If an attempt is made to change a parameter setting, the display will flash "GE". If the drive is not programmed with OEM default settings, the display will flash "GF" if this option is selected.
- 03 RESET OEM: Resets the user parameters to the OEM default settings. If the drive is not programmed with OEM default settings, the display will flash "GF" if this option is selected.

- 04     RESET 60: Resets the users parameters to the factory defaults for a 60 Hz base frequency.
- 05     RESET 50: Resets the user parameters to the factory defaults for a 50 Hz base frequency. Parameters 24, 27, and 40 will reset to 50.0 Hz.
- 06     TRANSLATE: If an EPM from a drive with a previous parameter version is installed in a new drive, the new drive will function like the previous version drive, but none of the parameter settings can be changed (“cE” will be displayed if this is attempted). The TRANSLATE function converts the EPM to the new parameter version so that the parameters can be changed, but it also retains the old parameter settings so the new dive will operate like the old drive without having to re-program all of the parameters.

**NOTE 1:** If the user parameters are reset to the OEM defaults (using the RESET OEM option), and then OPERATE WITH USER SETTINGS is selected, the USER settings will be the same as the OEM default settings. This allows the drive to operate as if it was in OEM mode, but the parameter values can be changed. This is useful if some of the OEM default settings need to be fine-tuned for proper operation. The new parameter values are not actually stored as new OEM default settings however, they are simply stored as new USER settings. Therefore, if the parameters are reset to the OEM defaults again, the parameters that were changed will be reset to their “old” value. The optional EPM Programmer is required to change OEM default settings. Refer to Section 13.2.

**NOTE 2:** Only the TRANSLATE (06) function can be performed while the drive is running. The display will flash “Er” if an attempt is made to select any other function while the drive is running.

**P50       FAULT HISTORY**

The FAULT HISTORY stores the last eight faults that tripped the drive. Refer to Section 16.0 - TROUBLESHOOTING for a list of the faults and possible causes.

Use the ▲ and ▼ buttons to scroll through the fault entries. The far left digit of the display will be the fault number and the remaining two digits will be the fault code. The faults are stored from newest to oldest, with the first fault shown being the most recent.

The display will read “\_ \_” if the FAULT HISTORY does not contain any fault messages.

**P51       SOFTWARE VERSION**

This displays the software version number for the control board software. This information is useful when contacting the factory for programming or troubleshooting assistance.

The software version is displayed in two parts which alternate. The first part is the software version, and the second part is the revision number. For example, if the display shows “64-” and “-02”, this indicates that the drive contains the second revision of version 64 software.

**P52 DC BUS VOLTAGE**

This displays the DC bus voltage in percent of nominal. Nominal DC bus voltage is determined by multiplying the drive's nameplate input voltage rating by 1.4.

**P53 MOTOR VOLTAGE**

This displays the output voltage in percent of the drive's nameplate output voltage rating.

**P54 MOTOR LOAD**

This displays the motor load in percent of the drive's output current rating.

**P55 0-10 VDC ANALOG INPUT**

This displays the level of the 0-10 VDC analog input signal at TB-5. A reading of 100% indicates a 10 VDC input at TB-5.

**P56 4-20 mA ANALOG INPUT**

This displays the level of the 4-20 mA analog input signal at TB-25. A reading of 20% indicates a 4 mA input at TB-25, and a reading of 100% indicates a 20 mA input at TB-25.

**P57 TERMINAL STRIP STATUS**

This indicates that status of several terminals using the vertical segments of the LED display. An illuminated segment indicates that the particular terminal is closed with respect to TB-2. The CHARGE RELAY is not a terminal, and should always be illuminated. See the diagram below:

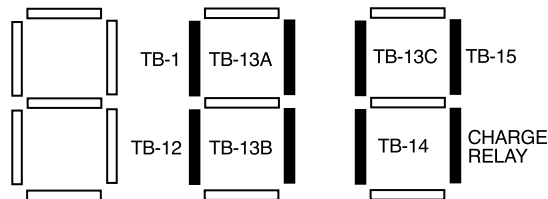



**P58      KEYPAD AND PROTECTION STATUS**

This indicates the status of the buttons on the keypad, and the status of the protective circuitry in the drive, using the horizontal segments of the LED. An illuminated segment indicates that the corresponding button is pressed, or the protective circuit is active. See the diagram below:

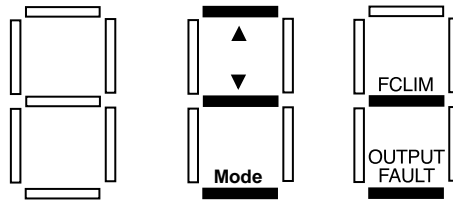

**NOTE:** FCLIM is an abbreviation for Fast Current Limit.

**P59-P60    TB-30 and TB-31 ANALOG OUTPUT**

This displays the level of the analog output signals at TB-30 (Parameter 59) and TB-31 (Parameter 60). A reading of 100% indicates that the output is 10 VDC.

## 16.0 TROUBLESHOOTING

To aid in troubleshooting, Parameters 50 through 60 can be accessed without entering the PASSWORD. Simply press the **Mode** button twice to “skip” over the PASSWORD prompt, and “P50” will be displayed to indicate that the parameter menu has been entered and Parameter 50 (FAULT HISTORY) can be viewed. The ▲ and ▼ buttons can be used to scroll from Parameter 50 to Parameter 60. Once the desired parameter is found, press the **Mode** button to view its “contents”. When finished, press **Mode** to exit the parameter menu. An example is shown below:

Press **Mode** once

Display reads “00”

Upper right decimal point blinks

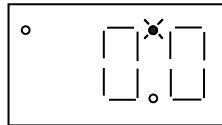

Press **Mode** again

Display reads “P50” (FAULT HISTORY)

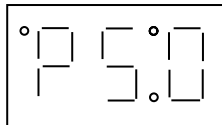

Use ▲ and ▼ to scroll to the desired parameter number

(In this example Parameter 54 has been selected, which is MOTOR LOAD)

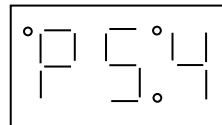

Press **Mode** to view parameter contents  
(77 = 77% LOAD)

Upper right decimal point blinks

Press **Mode** again to exit

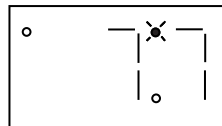

In the example above, Parameter 54 - MOTOR LOAD is being viewed. The “77” in the example indicates that the load on the motor is 77% of the output current rating of the drive.

The table below lists the fault conditions that will cause the drive to shut down, as well as some possible causes. Please contact the factory for more information on troubleshooting faults.

FAULT MESSAGES	
FAULT	DESCRIPTION & POSSIBLE CAUSES
AF	High Temperature Fault: Ambient temperature is too high; Cooling fan has failed (if equipped).
CF	Control Fault: A blank EPM, or an EPM with corrupted data has been installed. Perform a factory reset using Parameter 48 - PROGRAM SELECTION.
cF	Incompatibility Fault: An EPM with an incompatible parameter version has been installed. Either remove the EPM or perform a factory reset (Parameter 48) to change the parameter version of the EPM to match the parameter version of the drive.
dF	Dynamic Braking Fault: The drive has sensed that the dynamic braking resistors are overheating and shuts down to protect the resistors.
EF	External Fault: TB-13A and/or TB-13C is set as an External Fault input and TB-13A and/or TB-13C is open with respect to TB-2. Refer to Parameter 10 and/or 12.
GF	Data Fault: User data and OEM defaults in the EPM are corrupted.
HF	High DC Bus Voltage Fault: Line voltage is too high; Deceleration rate is too fast; Overhauling load. For fast deceleration or overhauling loads, dynamic braking may be required.
JF	Serial Fault: The watchdog timer has timed out, indicating that the serial link has been lost.
LF	Low DC Bus Voltage Fault: Line voltage is too low.
OF	Output Transistor Fault: Phase to phase or phase to ground short circuit on the output; Failed output transistor; Boost settings are too high; Acceleration rate is too fast.
PF	Current Overload Fault: VFD is undersized for the application; Mechanical problem with the driven equipment.
SF	Single-phase Fault: Single-phase input power has been applied to a three-phase drive.
UF	Start Fault: Start command was present when the drive was powered up. Must wait 2 seconds after power-up to apply Start command if START METHOD is set to NORMAL.
F1	EPM Fault: The EPM is missing or damaged.
F2 - F9, Fo	Internal Faults: The control board has sensed a problem - consult factory.

To clear a fault, issue a STOP command, either on the terminal strip, or using the STOP button on the optional remote keypad. The fault will only clear if the condition that caused the fault has passed. For example, if the drive trips on a LOW DC BUS VOLTAGE FAULT (LF) due to low input voltage, the fault cannot be cleared until the input voltage returns to a normal level.

If the drive is programmed to automatically restart after a fault (see Parameter 03), the drive will attempt to restart three times after a fault (the drive will not restart after CF, cF, GF, F1, F2-F9, or Fo faults). If all three restart attempts are unsuccessful, the drive will trip into FAULT LOCKOUT (LC), which requires a manual reset as described above.

## 17.0 SM-Plus™ DISPLAY MESSAGES

The following describes the various displays and messages that can appear on the SM-Plus™ drive.

### 17.1 SPEED DISPLAY

If the drive is in a STOP state (indicated by “\_ \_ \_” on the display), and the commanded speed is changed, the display will show the commanded speed, and the upper left decimal point will turn on solid. About five seconds after a change is made, the display will begin to alternate between the commanded speed value and the “\_ \_ \_” display. If the **Mode** button is pressed, the display will stop alternating and show the “\_ \_ \_” display only.

When the drive is given a START command, the displayed speed will start increasing as the drive accelerates up to the commanded speed. If the commanded speed is changed while the drive is running, the display will show the commanded speed rather than the actual speed, until the actual speed reaches the commanded speed.

If the commanded speed is changed faster than the drive can accelerate or decelerate, the upper left decimal point will blink to indicate that the drive is accelerating or decelerating to the new speed. Once the actual speed reaches the commanded speed, the upper left decimal point will turn on solid for 5 seconds and then turn off to indicate that the commanded speed has been reached, and that the display is now showing the actual speed.

### 17.2 CHANGING THE SPEED REFERENCE SOURCE

When the speed source is changed while the drive is running, the display will flash the message for the new speed source to indicate that the new speed source is active. Also, if the drive is being controlled from a speed source other than the ▲ and ▼ buttons (0-10 VDC, 4-20 mA, etc), and one of the ▲ or ▼ buttons is pressed, the display will flash the present speed source message to indicate that the ▲ and ▼ buttons are invalid.

**Example 1:** The drive is running and the present speed source is the keypad. TB-13A is programmed to select a 4-20 mA signal as the speed source. When TB-13A is closed to TB-2, the display will flash “EI” to indicate that the speed source has changed to the 4-20 mA signal. If the contact between TB-13A and TB-2 is opened, the display will flash “CP” to indicate that the speed source has changed back to the ▲ and ▼ buttons.

**Example 2:** The speed source is a 0-10 VDC signal. If the ▲ or ▼ button is pushed, the display will flash “EU” to indicate that the present speed source is the 0-10 VDC signal and that the ▲ and ▼ buttons are invalid.

Refer to the table on the next page for the possible speed reference source displays:

SPEED SOURCE DISPLAYS	
DISPLAY	DESCRIPTION
CP	CONTROL PAD: Speed is set using the ▲ and ▼ buttons on the front of the drive.
EI	EXTERNAL CURRENT: Speed is controlled by a 4-20 mA signal wired to TB-25 and TB-2.
EU	EXTERNAL VOLTAGE: Speed is controlled by a 0-10 VCD signal wired to TB-5 and TB-2.
JG	JOG: The drive is in Jog mode, and the speed is set by Preset Speed #2 (Parameter 32).
OP	MOP (Motor Operated Pot): Contacts wired to TB-13B and TB-13C are used to increase and decrease the drive speed.
Pr1 - Pr7	PRESET SPEEDS #1-7: Speed is set by the indicated Preset Speed (Parameters 31-37).

**NOTE:** The speed source displays will flash when the speed reference source is changed while the drive is running to indicate that the new speed reference source is active.

### 17.3 STATUS AND WARNING MESSAGES

STATUS AND WARNING MESSAGES	
DISPLAY	DESCRIPTION
br	DC BRAKING: The DC braking circuit is activated.
CL	CURRENT LIMIT: The output current has exceeded the CURRENT LIMIT setting (Parameter 25) and the drive is reducing the output frequency to reduce the output current. If the drive remains in CURRENT LIMIT for too long, it can trip into a CURRENT OVERLOAD fault (PF).
Er	ERROR: Invalid data has been entered or an invalid command was attempted.
GE	"GE" will be displayed if an attempt is made to change the OEM default settings when the drive is operating in the OEM mode (see Parameter 48).
GF	If "GF" is displayed when a RESET OEM is attempted, it indicates that the OEM defaults in the EPM are corrupted. If "GF" is displayed upon power-up, it indicates that the OEM defaults and the user settings in the EPM are corrupted. Refer to Section 13.2.
LC	FAULT LOCKOUT: The drive has failed three restart attempts and now requires a manual reset.
SE	SERIAL: The optional remote keypad is active as the user interface instead of the buttons on the front of the drive. See Parameter 14 - CONTROL.
SP	START PENDING: "SP" blinks during the interval between restart attempts.
✕ ✕	DECEL OVERRIDE (both upper decimal points blinking): The drive has stopped decelerating to avoid tripping into an HF fault due to regenerative energy from the motor.

## APPENDIX B – PI SETPOINT CONTROL OPTION

The following describes the PI Setpoint Control software option for the SM-Plus™ drive. This software option has additional parameters compared to the standard SM-Plus™ drive. Also, some of the parameters found in the standard drive have changed in the PI version.

PI Setpoint Control allows the SM-Plus™ drive to maintain a process setpoint, such as PSI or CFM, without using an external controller. When PI is activated the SM-Plus™ will operate in a closed-loop fashion, automatically adjusting the motor speed to maintain the process setpoint.

PI setpoint control requires feedback from the process in order to compare the actual process value to the setpoint. The difference between this value and the setpoint is called the error. The SM-Plus™ drive will increase or decrease the motor speed in an attempt to minimize the error. By constantly adjusting the motor speed, the PI control will drive the process toward the setpoint. Refer to the PI block diagram below:

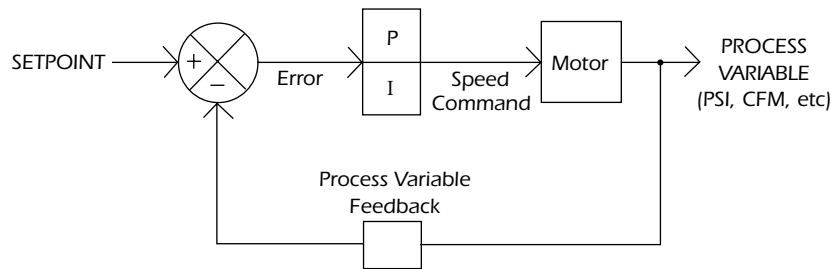

### B.1 DIRECT ACTING vs. REVERSE ACTING SYSTEMS

The PI function must be set to match the type of system that it will control. A direct (or normal) acting system requires an increase in motor speed if the process variable decreases. A reverse acting system requires a decrease in motor speed if the process variable decreases. Parameter 61 - PI MODE must be programmed to the setting that matches the system (normal or reverse acting) and also the type of feedback signal that is used (0-10 VDC or 4-20 mA).

### B.2 FEEDBACK DEVICES

A transducer or transmitter is required to monitor the process variable and provide feedback to the PI unit in order to compare the process value with the desired setpoint. A transducer outputs a signal corresponding to a fixed range of the process variable. A transmitter provides offset and gain adjustments to allow the output signal to be adjusted to correspond to different ranges of the process variable. Typical output signals for transducers and transmitters are 0-10 VDC or 4-20 mA.

**NOTE:** If a 4-20 mA signal is used for feedback, and the signal is lost, the drive will display “FL” to indicate the lost signal. The signal is considered lost if it drops below 2 mA.

### B.3 SETPOINT REFERENCES

The following references can be used to adjust the process setpoint:

1. Keypad (▲ and ▼ buttons)
2. 0-10 VDC signal (from speed pot or other source)
3. 4-20 mA signal
4. Preset Setpoints (using Preset Speeds #4 and #5)

**NOTE:** The setpoint reference and the PI feedback cannot be the same signal. If the drive is mistakenly programmed so that the setpoint reference is the same as the feedback reference, the setpoint reference will default to the ▲ and ▼ buttons.

### B.4 ADDITIONS TO THE STANDARD PARAMETER MENU

NO.	PARAMETER NAME	RANGE OF ADJUSTMENT	FACTORY DEFAULT
06	TB-14 OUTPUT	MIN ALARM (11), MAX ALARM (12),	NONE (01)
13	TB-15 OUTPUT	MIN/MAX ALARM (13),	NONE (01)
10	TB-13A FUNCTION	KEYPAD SETPOINT (12)	NONE (01)
11	TB-13B FUNCTION	KEYPAD SETPOINT (09)	NONE (01)
12	TB-13C FUNCTION	KEYPAD SETPOINT (10)	NONE (01)
45	SPD AT MIN SIGNAL	MINIMUM FREQ - 999.0 Hz	0.0 Hz
46	SPD AT MAX SIGNAL	MINIMUM FREQ - 999.0 Hz	60.0 Hz
61	PI MODE	OFF (01), NORMAL 4-20 mA (02), NORMAL 0-10 VDC (03), REVERSE 4-20 mA (04), REVERSE 0-10 VDC (05)	OFF (01)
62	MIN FEEDBACK	0.0 - 999.0	0.0
63	MAX FEEDBACK	0.0 - 999.0	100.0
64	PROPORTIONAL GAIN	0.0 - 99.9 %	5.0 %
65	INTEGRAL GAIN	0.0 - 99.9 SEC	0.0 SEC
66	PI ACCEL/DECEL	0.0 - 999.0 SEC	20.0 SEC
67	MIN ALARM	0.0 - 999.0	0.0
68	MAX ALARM	0.0 - 999.0	0.0
69	0-10 VDC FEEDBACK	(VIEW - ONLY)	(N/A)
70	4-20 mA FEEDBACK	(VIEW - ONLY)	(N/A)
71	ACTUAL FEEDBACK	(VIEW - ONLY)	(N/A)

## **B.5 DESCRIPTION OF PI PARAMETERS**

### **P10 TB-13A FUNCTION SELECT**

- 12 KEYPAD SETPOINT: This option has been added so that the ▲ and ▼ buttons on the front of the drive can be used as the PI setpoint reference source. Closing TB-13A to TB-2 will enable the PI mode and the ▲ and ▼ buttons can be used to select the desired process setpoint.

### **P11 TB-13B FUNCTION SELECT**

- 09 KEYPAD SETPOINT: This option has been added so that the ▲ and ▼ buttons on the front of the drive can be used as the PI setpoint reference source. Closing TB-13A to TB-2 will enable the PI mode and the ▲ and ▼ buttons can be used to select the desired process setpoint.

### **P12 TB-13C FUNCTION SELECT**

- 10 KEYPAD SETPOINT: This option has been added so that the ▲ and ▼ buttons on the front of the drive can be used as the PI setpoint reference source. Closing TB-13A to TB-2 will enable the PI mode and the ▲ and ▼ buttons can be used to select the desired process setpoint.

### **P61 PI MODE**

This parameter must be set to match the type of system and the type of feedback signal used. A direct acting system is one that requires the motor speed to increase as the feedback signal decreases, while a reverse acting system requires the motor speed to decrease as the feedback signal decreases.

- |    |                  |                                                                                      |
|----|------------------|--------------------------------------------------------------------------------------|
| 01 | DISABLED         | Disables the PI function to allow standard drive operation.                          |
| 02 | NORMAL 4-20 mA   | Enables the PI function for a direct acting system with a 4-20 mA feedback signal.   |
| 03 | NORMAL 0-10 VDC  | Enables the PI function for a direct acting system with a 0-10 VDC feedback signal.  |
| 04 | REVERSE 4-20 mA  | Enables the PI function for a reverse acting system with a 4-20 mA feedback signal.  |
| 05 | REVERSE 0-10 VDC | Enables the PI function for a reverse acting system with a 0-10 VDC feedback signal. |

When PI is disabled, the drive will operate in an OPEN LOOP mode, responding directly to a speed reference source selected using STANDARD SPEED SOURCE (Parameter 05) or terminals TB-13A, 13B, and/or 13C).

### **P62 MIN FEEDBACK**

This parameter should be set to the value of the process variable that corresponds to the minimum transducer feedback signal (0 VDC or 4 mA). See the example below:



**P63      MAX FEEDBACK**

This parameter should be set to the value of the process variable that corresponds to the maximum transducer feedback signal (10 VDC or 20 mA). See the example below:

**Example:** A 0-100 psi transducer outputs 4 mA at 0 psi and 20 mA at 100 psi. Set MIN FEEDBACK to 0, and set MAX FEEDBACK to 100. The setpoint will then be adjustable between 0 and 100.

**NOTE:** If a reverse acting feedback device is being used, MIN FEEDBACK should be set to the maximum process variable value, and MAX FEEDBACK should be set to the minimum process variable value.

**P64      PROPORTIONAL GAIN**

The Proportional Gain setting represents the speed command output (in % of maximum speed) that results from each 1% of error.

**P65      INTEGRAL GAIN**

The Integral Gain setting represents the ramp rate of the speed command output (in % of maximum speed per second) that results from each 1% of error.

**P66      PI ACCEL/DECEL**

When the PI unit attempts to respond to a sudden step change in setpoint, the result can be unstable operation. This parameter acts like a “filter” and ramps the setpoint from the old value to the new value over a programmable period of time to smooth the PI unit’s response. If PI ACCEL/DECEL is set to 0.0 seconds, it is effectively disabled.

**P67      MIN ALARM**

This parameter represents the process value that the feedback signal must fall below to activate the MIN ALARM output (see Parameters 6 and 13).

**P68      MAX ALARM**

This parameter represents the process value that the feedback signal must exceed to activate the MAX ALARM output (see Parameters 6 and 13).

**NOTE:** The MIN ALARM function can be used to start and stop the drive based on the level of the PI feedback signal. This is done by wiring a 2-wire start/stop circuit through the drive’s open-collector output, and setting the open-collector output for MIN ALARM (see Parameters 6 and 13). When the signal drops below the MIN ALARM setting, the open-collector output will de-energize, which will stop the drive. When the signal is equal to or greater than the MIN ALARM setting, the open-collector output will energize and start the drive.

**P69      0-10 VDC FEEDBACK**

This can be used to monitor the PI feedback when using a 0-10 VDC feedback signal. The displayed value will be scaled according to the MIN and MAX FEEDBACK parameters (62 and 63).

**P70      4-20 mA FEEDBACK**

This can be used to monitor the PI feedback when using a 4-20 mA feedback signal. The displayed value will be scaled according to the MIN and MAX FEEDBACK parameters (62 and 63).

**P71      ACTUAL FREQUENCY**

This can be used to monitor the actual output frequency of the drive when operating in PI mode, as the normal display is scaled to PI units according to the MIN and MAX FEEDBACK parameters.

**B.6      DESCRIPTION OF OTHER PARAMETERS**

In addition to the PI feature, two parameters have been added, and additional options have been added to the open-collector status outputs:

**P06/P13    TB-14/TB-15 OUTPUT**

Three more options have been added to the open-collector outputs:

- 11      MIN ALARM: Opens when the feedback signal falls below the MIN ALARM setting.
- 12      MAX ALARM: Opens when the feedback signal exceeds the MAX ALARM setting.
- 13      MIN/MAX ALARM: Opens when the feedback signal falls below the MIN ALARM setting or exceeds the MAX ALARM setting.

**P45      SPEED AT MIN SIGNAL**

This sets the speed at which the drive will run when it receives the minimum speed reference signal (0 VDC or 4 mA). This is used in conjunction with SPEED AT MAX SIGNAL (Parameter 46) to define the speed range of the drive when following an analog speed reference signal.

**P46      SPEED AT MAX SIGNAL**

This sets the speed at which the drive will run when it receives the maximum speed reference signal (10 VDC or 20 mA). This is used in conjunction with SPEED AT MIN SIGNAL (Parameter 45) to define the speed range of the drive when following an analog speed reference signal.

**NOTE:** If SPEED AT MIN SIGNAL is set higher than the SPEED AT MAX SIGNAL, the drive will react inversely to the speed reference signal. Therefore, as the speed reference signal increases, the drive speed will decrease, and vice-versa.

## B.7 SM-Plus™ PI CONTROL WIRING EXAMPLES

The following diagrams illustrate the most common PI control configurations. The wiring and corresponding parameter settings are given. In these examples, TB-13A is used to select the setpoint reference (TB-13B or TB-13C could also be used for this function). The examples show a 2-wire start/stop circuit.

### Example 1: Keypad Setpoint and 4-20 mA Feedback

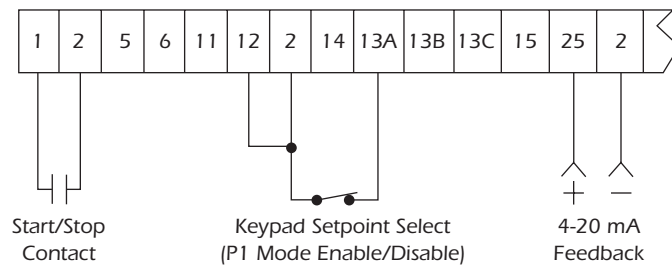

- Set PI MODE (Parameter 61) to NORMAL 4-20 mA (02) or REVERSE 4-20 mA (04) depending on the system. Refer to section B.1 to determine whether the system is normal or reverse acting.
- Set TB-13A FUNCTION SELECT (Parameter 10) to KEYPAD SETPOINT (12).
- Close TB-13A to TB-2 to put the drive into PI mode. The ▲ and ▼ buttons can then be used to adjust the PI setpoint.
- Open TB-13A to TB-2 to disable PI mode and control speed directly by the method selected in STANDARD SPEED SOURCE (Parameter 05). For example, if Parameter 5 is set to 0-10 VDC, a speed pot could be used for manual speed control when the PI mode is disabled.

**NOTE 1:** When TB-13A is closed to TB-2, the drive's display will flash "PIC" to indicate the drive is in PI Control mode. When TB-13A is opened, the display will flash "SPd" to indicate the drive is in Speed Control mode.

**NOTE 2:** The setpoint reference and the PI feedback cannot be the same signal. If the drive is mistakenly programmed so that the setpoint reference is the same as the feedback reference, the setpoint reference will default to the ▲ and ▼ buttons.

**Example 2: Speed Pot Setpoint and 4-20 mA Feedback**

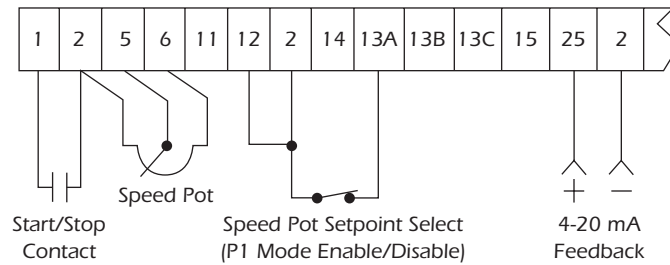

- Set PI MODE (Parameter 61) to NORMAL 4-20 mA (02) or REVERSE 4-20 mA (04) depending on the system. Refer to section B.1 to determine whether the system is normal or reverse acting.
- Set TB-13A FUNCTION SELECT (Parameter 10) to 0-10 VDC (02).
- Close TB-13A to TB-2 to put the drive into PI mode. The Speed Pot can then be used to adjust the PI setpoint.
- Open TB-13A to TB-2 to disable PI mode and control speed directly by the method selected in STANDARD SPEED SOURCE (Parameter 05). For example, if Parameter 5 is set to 0-10 VDC, a speed pot could be used for manual speed control when the PI mode is disabled. In this case, one speed pot would serve two purposes: adjusting the setpoint when PI mode is enabled, and adjusting the motor speed directly when PI mode is disabled.

**NOTE 1:** When TB-13A is closed to TB-2, the drive's display will flash "PIC" to indicate the drive is in PI Control mode. When TB-13A is opened, the display will flash "SPd" to indicate the drive is in Speed Control mode.

**NOTE 2:** The setpoint reference and the PI feedback cannot be the same signal. If the drive is mistakenly programmed so that the setpoint reference is the same as the feedback reference, the setpoint reference will default to the ▲ and ▼ buttons.

## B.8 TUNING THE PI CONTROL

Once the PI control is configured properly, it needs to be tuned in order to maintain the process setpoint. First, set the Integral Gain (Parameter 65) to zero, and increase the Proportional Gain (Parameter 64) until the system becomes unstable, then lower the gain until the system stabilizes again. Set the Proportional Gain about 15% less than that value that stabilizes the system. If only Proportional Gain is used, and the system is operating in a steady-state condition (setpoint is fixed and process variable has settled to a fixed value), there will always be a certain amount of error in the system. This is called the steady-state error.

Integral Gain (Parameter 65) is used to force the steady-state error to zero by increasing the output speed command with respect to time. Over time, the error will be forced to zero because the Integral term will continue to change the speed command, even after the Proportional term reaches steady state and no longer affects the speed command. The Integral Gain affects the rate of rise of the output speed command from the Integral term. Small amounts of Integral Gain can cause large changes in PI performance, so care must be taken when adjusting Integral Gain. Too much Integral Gain will result in overshoots, especially if large step changes in error occur.

The other parameter setting that affects the response of the PI control is Parameter 66 - PI ACCEL/DECEL. This sets the acceleration and deceleration rate of the setpoint reference into the PI unit. When the setpoint changes, this function will “filter” the input to the PI unit by ramping the setpoint reference from the previous value to the new value. This will help prevent overshoots that can occur when the PI control attempts to respond to step changes in setpoint, resulting in smoother operation. If PI ACCEL/DECEL is set to 0.0 seconds, it is effectively disabled.

## B.9 ADDITIONAL STATUS DISPLAYS

The PI option contains additional messages that may appear on the display:

PI OPTION DISPLAYS	
DISPLAY	DESCRIPTION
ACP	AUTO CONTROL PAD: The ▲ and ▼ buttons are used to adjust the setpoint in PI mode.
nCP	MANUAL CONTROL PAD: The ▲ and ▼ buttons are used for manual speed control when PI mode is enabled but the drive is operating in open-loop mode.
FL	FOLLOWER LOST: If a 4-20 mA signal is used as a speed reference, PI setpoint reference, or PI feedback, and the signal drops below 2 mA, the drive will trip and display “FL” to indicate that the signal is lost.

## LEESON Electric

Variable Speed AC Motors Drives

### EC DECLARATION OF CONFORMITY

In accordance with EN45014:1998

**Applied Council Directive(s):** EMC Directive 89/336/EEC, as amended: 92/31/EEC and Low Voltage Directive 73/23/EEC, as amended: 93/68/EEC

We LEESON Electric  
2100 Washington Street  
Grafton, WI 53024  
U.S.A.

declare under our sole responsibility that the products to which this Declaration relates, are in conformity with the relevant provisions of the following standards, provided that installations are carried out in accordance with manufacturer's instructions.

#### PRODUCTS RELATED TO DECLARATION

SM-Plus™ AC Variable Frequency Motor Drives Models:

174429	174430	174431	174432	174433	174434	174435
174436	174438	174439	174440	174441	174442	174443
174444	174445	174446	174447	174448	174452	174453
174454	174455	174456	174457	174458	174459	174460
174461	174462	174463	174464	174491	174492	174493
174493.10	174494	174495	174497			

Models 174111 thru 174139; Models 174201 thru 174203; Models 174213 thru 174240.

#### RELEVANT EUROPEAN STANDARDS

EN 50081-2\* Electromagnetic compatibility  
– Generic emission standard – Part 2: Industrial environment  
EN 50082-2\* Electromagnetic compatibility  
– Generic immunity standard – Part 2: Industrial environment  
EN 50178:1998 Electronic equipment for use in power installations  
\* with suitable line filters that are properly installed.

**YEAR OF CE Marking (Low Voltage Directive): 1999**

Signature:

  
John Rydeski, Agency Project Engineer

Dated this 27th day of June 2002.





**LEESON ELECTRIC**

GRAFTON, WISCONSIN 53024-0241 U.S.A.

TEL (262)377-8810 FAX (262)377-9025 [www.leeson.com](http://www.leeson.com)

*A REGAL-BELOIT Company*



SF06K

3837S/2-03/7500/TR/BH