

Motore Normale / Normal Motor

460 V -60 Hz - 3ph

230V -60 Hz - 3ph

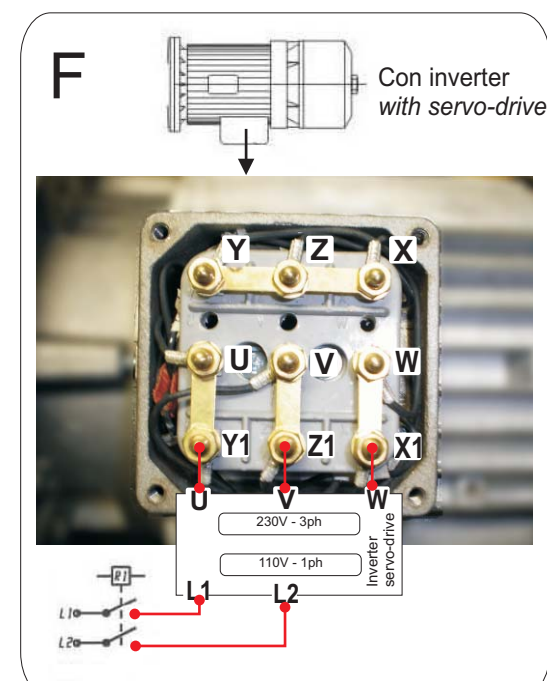
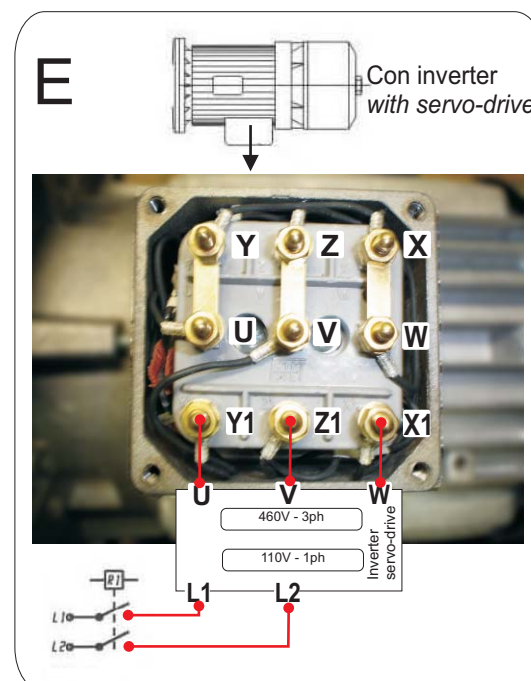
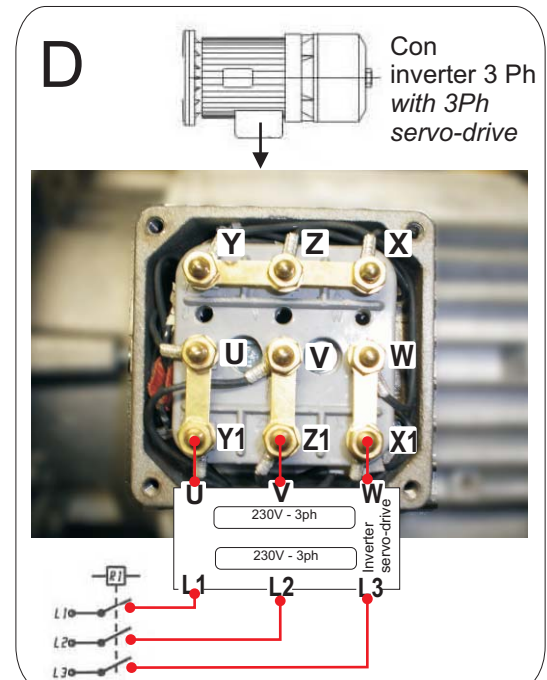
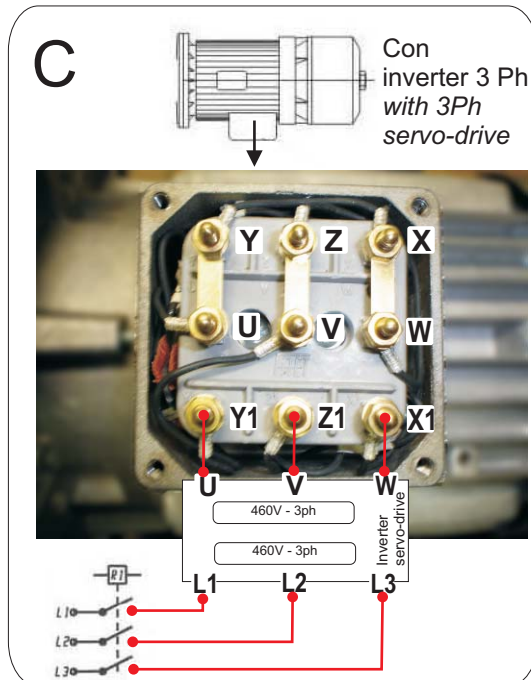
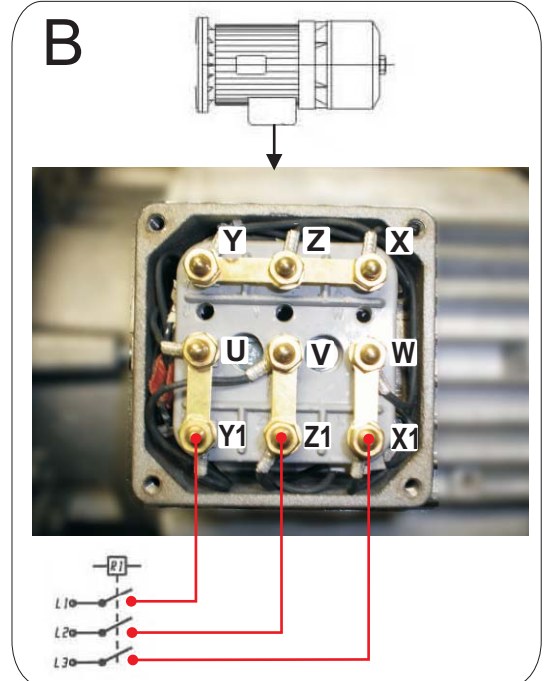
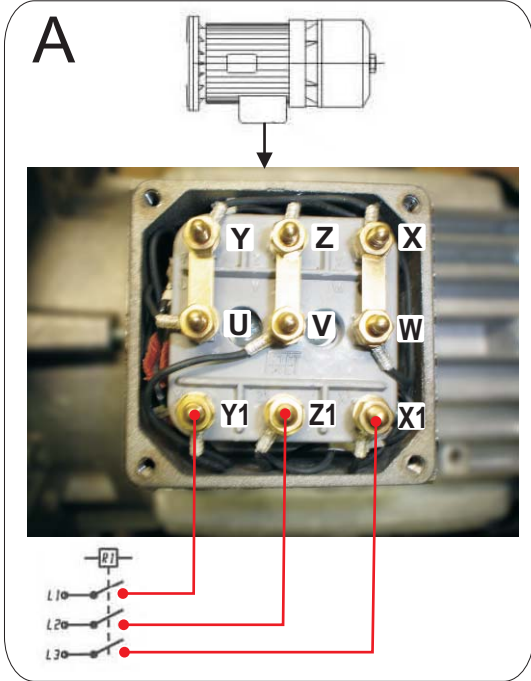

Motore con freno a 3 Ph / 3Ph motor with brake

460 V -60 Hz - 3ph

230V -60 Hz - 3ph

G

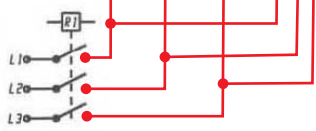
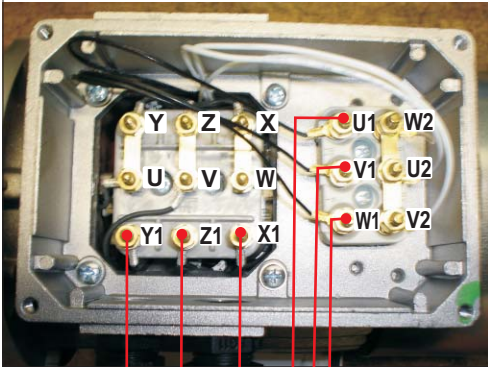
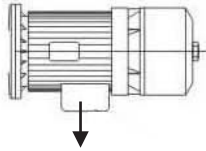

H

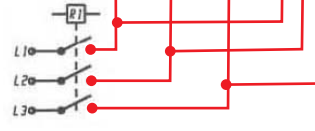
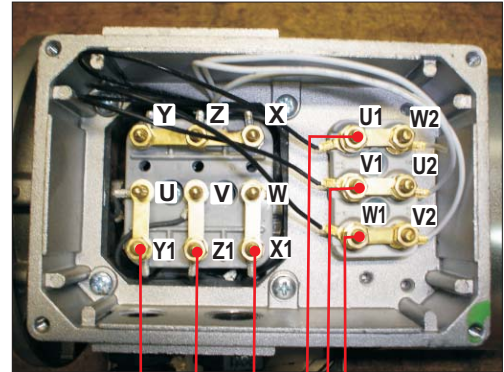
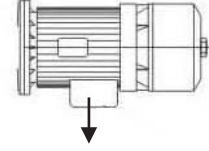

I

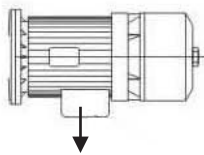

Con
inverter 3 Ph
with 3Ph
servo-drive

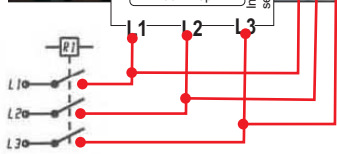
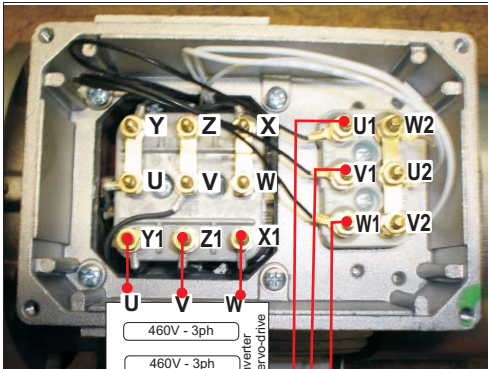

L

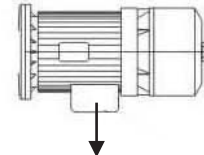

Con
inverter 3 Ph
with 3Ph
servo-drive

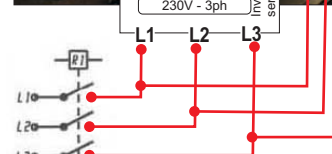
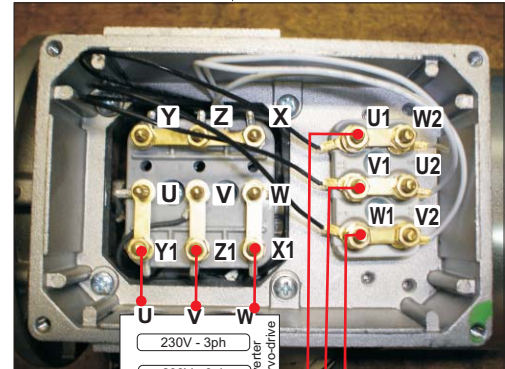

Motore 3Ph con ventola 1Ph / 3Ph motor with 1Ph fan

460 V -60 Hz

230V -60 Hz

